



B2338, B2442, M1242, MS321, MS421 Printers

User's Guide

March 2024

www.lexmark.com

Machine type(s):

4600

Models:

230, 238, 430, 438, 490

Contents

- Safety information..... 5**
 - Conventions..... 5
 - Product statements..... 5

- Learning about the printer..... 8**
 - Finding information about the printer.....8
 - Selecting a location for the printer..... 9
 - Printer configurations..... 11
 - Attaching cables..... 11
 - Using the control panel..... 12
 - Understanding the status of the power button and indicator light..... 13

- Loading paper and specialty media..... 14**
 - Setting the size and type of the specialty media..... 14
 - Configuring Universal paper settings..... 14
 - Loading trays..... 14
 - Loading the multipurpose feeder..... 16
 - Linking trays..... 17

- Paper support..... 18**
 - Supported paper sizes..... 18
 - Supported paper types..... 19
 - Supported paper weights..... 20

- Printing..... 21**
 - Printing from a computer..... 21
 - Printing from a mobile device..... 21
 - Printing a font sample list..... 22

- Understanding the printer menus..... 23**
 - Menu map..... 23
 - Device..... 23
 - Print..... 30
 - Paper..... 38
 - Network/Ports..... 40

Reports.....	51
Troubleshooting.....	52
Printing the Menu Settings Page.....	52
Securing the printer.....	53
Locating the security slot.....	53
Erasing printer memory.....	53
Restoring factory default settings.....	54
Statement of Volatility.....	54
Maintaining the printer.....	55
Networking.....	55
Cleaning the printer.....	57
Ordering parts and supplies.....	57
Replacing parts and supplies.....	60
Moving the printer.....	70
Saving energy and paper.....	71
Recycling.....	72
Clearing jams.....	74
Avoiding jams.....	74
Identifying jam locations.....	75
Paper jam in door A.....	76
Paper jam in the rear door.....	79
Paper jam in the standard bin.....	80
Paper jam in the duplex unit.....	81
Paper jam in trays.....	82
Paper jam in the multipurpose feeder.....	82
Troubleshooting.....	84
Configuring the SMTP server.....	84
Network connection problems.....	84
Issues with supplies.....	86
Paper feed problems.....	87
Printing problems.....	90
Contacting customer support.....	118

Upgrading and migrating.....	119
Hardware.....	119
Software.....	124
Firmware.....	125
Notices.....	128
Index.....	139

Safety information

Conventions





Note: A *note* identifies information that could help you.

Warning: A *warning* identifies something that could damage the product hardware or software.







WARNING (in full capitals): A *WARNING* indicates a risk of death or serious injury if not avoided.

CAUTION: A *caution* indicates a potentially hazardous situation that could injure you.

Different types of caution statements include:

-  **CAUTION—POTENTIAL INJURY:** Indicates a risk of injury.
-  **CAUTION—SHOCK HAZARD:** Indicates a risk of electrical shock.
-  **CAUTION—HOT SURFACE:** Indicates a risk of burn if touched.
-  **CAUTION—TIPPING HAZARD:** Indicates a crush hazard.
-  **CAUTION—PINCH HAZARD:** Indicates a risk of being caught between moving parts.

Product statements

-  **CAUTION—POTENTIAL INJURY:** To avoid the risk of fire or electrical shock, connect the power cord to an appropriately rated and properly grounded electrical outlet that is near the product and easily accessible.
-  **CAUTION—POTENTIAL INJURY:** To avoid the risk of fire or electrical shock, use only the power cord provided with this product or the manufacturer's authorized replacement.
-  **CAUTION—POTENTIAL INJURY:** Do not use this product with extension cords, multioutlet power strips, multioutlet extenders, or UPS devices. The power capacity of these types of accessories can be easily overloaded by a laser printer and may result in a risk of fire, property damage, or poor printer performance.
-  **CAUTION—POTENTIAL INJURY:** Only a Lexmark Inline Surge Protector that is properly connected between the printer and the power cord provided with the printer may be used with this product. The use of non-Lexmark surge protection devices may result in a risk of fire, property damage, or poor printer performance.
-  **CAUTION—SHOCK HAZARD:** To avoid the risk of electrical shock, do not place or use this product near water or wet locations.
-  **CAUTION—SHOCK HAZARD:** To avoid the risk of electrical shock, do not set up this product or make any electrical or cabling connections, such as the power cord, fax feature, or telephone, during a lightning storm.

 **CAUTION—POTENTIAL INJURY:** Do not cut, twist, bind, crush, or place heavy objects on the power cord. Do not subject the power cord to abrasion or stress. Do not pinch the power cord between objects such as furniture and walls. If any of these things happen, a risk of fire or electrical shock results. Inspect the power cord regularly for signs of such problems. Remove the power cord from the electrical outlet before inspecting it.

 **CAUTION—SHOCK HAZARD:** To avoid the risk of electrical shock, make sure that all external connections (such as Ethernet and telephone system connections) are properly installed in their marked plug-in ports.

 **CAUTION—SHOCK HAZARD:** To avoid the risk of electrical shock, if you are accessing the controller board or installing optional hardware or memory devices sometime after setting up the printer, then turn the printer off, and unplug the power cord from the electrical outlet before continuing. If you have any other devices attached to the printer, then turn them off as well, and unplug any cables going into the printer.

 **CAUTION—SHOCK HAZARD:** To avoid the risk of electrical shock when cleaning the exterior of the printer, unplug the power cord from the electrical outlet and disconnect all cables from the printer before proceeding.





 **CAUTION—POTENTIAL INJURY:** If the printer weight is greater than 20 kg (44 lb), then it may require two or more people to lift it safely.



 **CAUTION—POTENTIAL INJURY:** When moving the printer, follow these guidelines to avoid personal injury or printer damage:

- Make sure that all doors and trays are closed.
- Turn off the printer, and then unplug the power cord from the electrical outlet.
- Disconnect all cords and cables from the printer.
- If the printer has separate floor-standing optional trays or output options attached to it, then disconnect them before moving the printer.
- If the printer has a caster base, then carefully roll it to the new location. Use caution when passing over thresholds and breaks in flooring.
- If the printer does not have a caster base but is configured with optional trays or output options, then remove the output options and lift the printer off the trays. Do not try to lift the printer and any options at the same time.
- Always use the handholds on the printer to lift it.
- Any cart used to move the printer must have a surface able to support the full footprint of the printer.
- Any cart used to move the hardware options must have a surface able to support the dimensions of the options.
- Keep the printer in an upright position.
- Avoid severe jarring movements.
- Make sure that your fingers are not under the printer when you set it down.
- Make sure that there is adequate clearance around the printer.

 **CAUTION—TIPPING HAZARD:** Installing one or more options on your printer or MFP may require a caster base, furniture, or other feature to prevent instability causing possible injury. For more information on supported configurations, see www.lexmark.com/multifunctionprinters.

 **CAUTION—TIPPING HAZARD:** To reduce the risk of equipment instability, load each tray separately. Keep all other trays closed until needed.

-  **CAUTION—HOT SURFACE:** The inside of the printer might be hot. To reduce the risk of injury from a hot component, allow the surface to cool before touching it.
-  **CAUTION—PINCH HAZARD:** To avoid the risk of a pinch injury, use caution in areas marked with this label. Pinch injuries may occur around moving parts, such as gears, doors, trays, and covers.
-  **CAUTION—POTENTIAL INJURY:** This product uses a laser. Use of controls or adjustments or performance of procedures other than those specified in the *User's Guide* may result in hazardous radiation exposure.
-  **CAUTION—POTENTIAL INJURY:** The lithium battery in this product is not intended to be replaced. There is a danger of explosion if a lithium battery is incorrectly replaced. Do not recharge, disassemble, or incinerate a lithium battery. Discard used lithium batteries according to the manufacturer's instructions and local regulations.

 WARNING	
<ul style="list-style-type: none"> • INGESTION HAZARD: This product contains a button cell or coin battery. • DEATH or serious injury can occur if ingested. • A swallowed button cell or coin battery can cause Internal Chemical Burns in as little as 2 hours. • KEEP new and used batteries OUT OF REACH of CHILDREN. • Seek immediate medical attention if a battery is suspected to be swallowed or inserted inside any part of the body. 	

Remove and immediately recycle or dispose of used batteries according to local regulations and keep away from children. Do not dispose of batteries in household trash or incinerate. Even used batteries may cause severe injury or death. Call a local poison control center for treatment information.

Battery type: CR6821

Nominal battery voltage: 3V

Do not force discharge, recharge, disassemble, heat above 60°C (140°F), or incinerate. Doing so may result in injury due to venting, leakage, or explosion resulting in chemical burns.

This product is designed, tested, and approved to meet strict global safety standards with the use of specific manufacturer's components. The safety features of some parts may not always be obvious. The manufacturer is not responsible for the use of other replacement parts.

Refer service or repairs, other than those described in the user documentation, to a service representative.

This product uses a printing process that heats the print media, and the heat may cause the media to release emissions. You must understand the section in your operating instructions that discusses the guidelines for selecting print media to avoid the possibility of harmful emissions.

This product may produce small amounts of ozone during normal operation, and may be equipped with a filter designed to limit ozone concentrations to levels well below the recommended exposure limits. To avoid high ozone concentration levels during extensive usage, install this product in a well-ventilated area and replace the ozone and exhaust filters if instructed to do so in the product maintenance instructions. If there are no references to filters in the product maintenance instructions, then there are no filters requiring replacement for this product.

SAVE THESE INSTRUCTIONS.

Learning about the printer

Finding information about the printer

What are you looking for?	Find it here
Initial setup instructions: <ul style="list-style-type: none"> • Connecting the printer • Installing the printer software 	See the setup documentation that came with the printer or go to http://support.lexmark.com .
More setup and instructions for using the printer: <ul style="list-style-type: none"> • Selecting and storing paper and specialty media • Loading paper • Configuring printer settings • Viewing and printing documents and photos • Setting up and using the printer software • Configuring the printer on a network • Caring for and maintaining the printer • Troubleshooting and solving problems 	<i>Information Center</i> —Go to http://infoserve.lexmark.com . <i>Help Menu Pages</i> —Access the guides on the printer firmware or go to http://support.lexmark.com . <i>Touch Screen Guide</i> —Go to http://support.lexmark.com . Product videos—Go to http://infoserve.lexmark.com/idv/ .
Information on setting up and configuring the accessibility features of your printer	<i>Lexmark Accessibility Guide</i> —Go to http://support.lexmark.com .
Help using the printer software	Help for Microsoft® Windows® or Macintosh operating systems—Open a printer software program or application, and then click Help . Click  to view context-sensitive information. Notes: <ul style="list-style-type: none"> • Help is automatically installed with the printer software. • Depending on the operating system, the printer software is located in the printer program folder or on the desktop.

What are you looking for?	Find it here
<p>The latest supplemental information, updates, and customer support:</p> <ul style="list-style-type: none"> • Documentation • Driver downloads • Live chat support • E-mail support • Voice support 	<p>Go to http://support.lexmark.com.</p> <p>Note: Select your country or region, and then select your product to view the appropriate support site.</p> <p>Support contact information for your country or region can be found on the website or on the printed warranty that came with the printer.</p> <p>Have the following information ready when you contact customer support:</p> <ul style="list-style-type: none"> • Place and date of purchase • Machine type and serial number 
<ul style="list-style-type: none"> • Safety information • Regulatory information • Warranty information • Environmental information 	<p>Warranty information varies by country or region:</p> <ul style="list-style-type: none"> • In the U.S.—See the Statement of Limited Warranty included with the printer, or go to http://support.lexmark.com. • In other countries and regions—See the printed warranty that came with the printer. <p><i>Product Information Guide</i>—See the documentation that came with the printer or go to http://support.lexmark.com.</p>

Selecting a location for the printer

- Leave enough room to open trays, covers, and doors and to install hardware options.
- Set up the printer near an electrical outlet.

 **CAUTION—POTENTIAL INJURY:** To avoid the risk of fire or electrical shock, connect the power cord to an appropriately rated and properly grounded electrical outlet that is near the product and easily accessible.

 **CAUTION—SHOCK HAZARD:** To avoid the risk of electrical shock, do not place or use this product near water or wet locations.

- Make sure that airflow in the room meets the latest revision of the ASHRAE 62 standard or the CEN Technical Committee 156 standard.
- Provide a flat, sturdy, and stable surface.
- Keep the printer:
 - Clean, dry, and free of dust
 - Away from stray staples and paper clips
 - Away from the direct airflow of air conditioners, heaters, or ventilators
 - Free from direct sunlight and humidity extremes
- Observe the recommended temperatures and avoid fluctuations.

Ambient temperature	10 to 32°C (50 to 90°F)
Storage temperature	0 to 40°C (32 to 104°F)

- Allow the following recommended amount of space around the printer for proper ventilation:

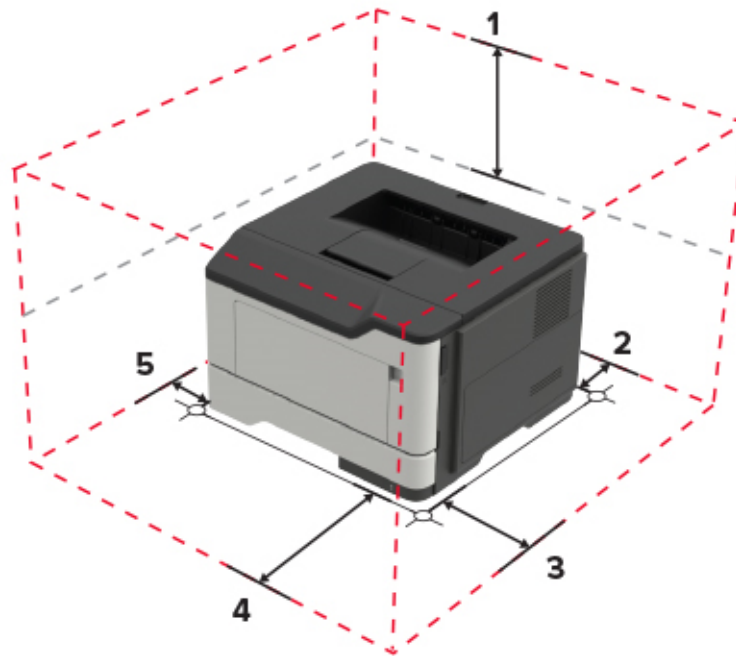

1	Top	305 mm (12 in.)
2	Rear	100 mm (3.94 in.)
3	Right side	110 mm (4.33 in.)
4	Front	305 mm (12 in.) Note: The minimum space needed in front of the printer is 76 mm (3 in.).
5	Left side	65 mm (2.56 in.)

Printer configurations

CAUTION—TIPPING HAZARD: Installing one or more options on your printer or MFP may require a caster base, furniture, or other feature to prevent instability causing possible injury. For more information on supported configurations, see www.lexmark.com/multifunctionprinters.

CAUTION—TIPPING HAZARD: To reduce the risk of equipment instability, load each tray separately. Keep all other trays closed until needed.

You can configure your printer by adding optional 250- or 550-sheet trays. For more information, see [“Installing optional trays” on page 123](#).



1	Control panel
2	Standard bin
3	Controller board access cover
4	Standard 250-sheet tray
5	Optional 250- or 550-sheet tray
6	Multipurpose feeder
7	Door A

Attaching cables

CAUTION—SHOCK HAZARD: To avoid the risk of electrical shock, do not set up this product or make any electrical or cabling connections, such as the power cord, fax feature, or telephone, during a lightning storm.

⚠ CAUTION—POTENTIAL INJURY: To avoid the risk of fire or electrical shock, connect the power cord to an appropriately rated and properly grounded electrical outlet that is near the product and easily accessible.

⚠ CAUTION—POTENTIAL INJURY: To avoid the risk of fire or electrical shock, use only the power cord provided with this product or the manufacturer's authorized replacement.

Warning—Potential Damage: To avoid loss of data or printer malfunction, do not touch the USB cable, any wireless network adapter, or the printer in the areas shown while actively printing.



	Use the	To
1	USB printer port	Connect the printer to a computer.
2	Power cord socket	Connect the printer to an electrical outlet.
3	Ethernet port	Connect the printer to a network.

Using the control panel

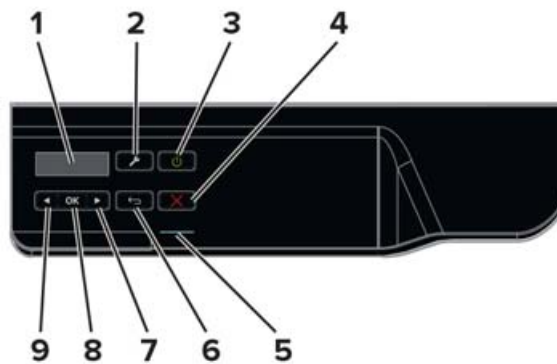

	Use the	To
1	Display	View printing options, printer status, and error messages.
2	Menus button	Open the menus.

	Use the	To
3	Power button	Turn on or turn off the printer. Note: To turn off the printer, press and hold the power button for five seconds.
4	Stop or Cancel button	Stop the current printer task.
5	Indicator light	Check the printer status.
6	Back button	Return to the previous screen.
7	Right arrow button	<ul style="list-style-type: none"> • Scroll through menus or move between screens and menu options. • Increase the numeric value of a setting being displayed.
8	Select button	<ul style="list-style-type: none"> • Select menu options. • Display available values or settings for a menu. An asterisk (*) indicates the current default setting. • Save settings.
9	Left arrow button	<ul style="list-style-type: none"> • Scroll through menus or move between screens and menu options. • Decrease the numeric value of a setting being displayed.

Understanding the status of the power button and indicator light

Indicator light	Printer status
Off	The printer is off or in Hibernate mode.
Blue	The printer is ready or processing data.
Red	The printer requires user intervention.

Power button light	Printer status
Off	The printer is off, ready, or processing data.
Solid amber	The printer is in Sleep mode.
Blinking amber	The printer is in Hibernate mode.

Loading paper and specialty media

Setting the size and type of the specialty media

1 From the home screen, navigate to:

 > Paper >  > Tray Configuration >  > Paper Size/Type > 

2 Select a paper source, and then configure the size and type of the specialty media.

Configuring Universal paper settings

1 From the control panel, navigate to:

 > Paper >  > Media Configuration >  > Universal Setup > 

2 Select **Portrait Width** or **Portrait Height**, and then press .

3 Adjust the settings, and then press .

Loading trays

 **CAUTION—TIPPING HAZARD:** To reduce the risk of equipment instability, load each tray separately. Keep all other trays closed until needed.

1 Remove the tray.

Note: To avoid paper jams, do not remove trays while the printer is busy.



- 2** Adjust the paper guides to match the size of the paper that you are loading.



- 3** Flex, fan, and align the paper edges before loading.



- 4** Load the paper stack with the printable side facedown, and then make sure that the side guides fit snugly against the paper.



Notes:

- Load letterhead facedown with the top edge of the sheet toward the front of the tray for one-sided printing.
- Load letterhead faceup with the bottom edge of the sheet toward the front of the tray for two-sided printing.
- Do not slide paper into the tray.
- To avoid paper jams, make sure that the stack height is below the maximum paper fill indicator.

- 5** Insert the tray.

If necessary, set the paper size and paper type from the control panel to match the paper loaded.

Loading the multipurpose feeder

- 1 Open the multipurpose feeder.

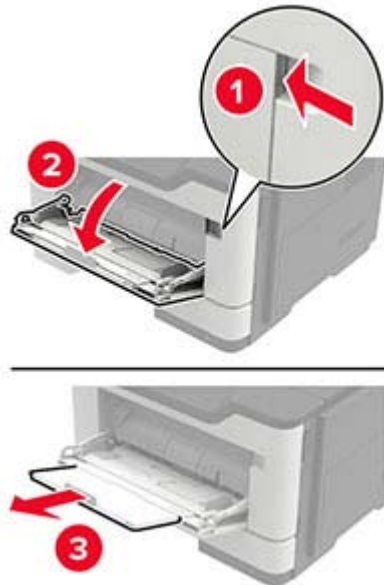

- 2 Adjust the guide to match the size of the paper that you are loading.



- 3 Flex, fan, and align the paper edges before loading.



- 4 Load paper with the printable side faceup.

Notes:

- Load letterhead faceup with the top edge of the sheet toward the front of the tray for one-sided printing.
- Load letterhead facedown with the bottom edge of the sheet toward the front of the tray for two-sided printing.

- Load envelopes with the flap facedown on the left side.
- Load European envelopes with the flap facedown and entering the printer first.

Warning—Potential Damage: Do not use envelopes with stamps, clasps, snaps, windows, coated linings, or self-stick adhesives.

5 From the control panel, set the paper size and paper type to match the paper loaded.

Linking trays

1 Open a web browser, and then type the printer IP address in the address field.

Notes:

- View the printer IP address on the printer home screen. The IP address appears as four sets of numbers separated by periods, such as 123.123.123.123.
- If you are using a proxy server, then temporarily disable it to load the web page correctly.

2 Click **Settings > Paper > Tray Configuration**.

3 Set the same paper size and paper type for the trays that you are linking.

4 Save the settings.

5 Click **Settings > Device > Maintenance > Configuration Menu > Tray Configuration**.

6 Set Tray Linking to **Automatic**.

7 Save the settings.

To unlink trays, make sure that no trays have the same paper size and paper type settings.

Warning—Potential Damage: The temperature of the fuser varies according to the specified paper type. To avoid printing issues, match the paper type setting in the printer with the paper loaded in the tray.

Paper support

Supported paper sizes

Paper size	Tray	Multipurpose feeder	Two-sided printing
A4 210 x 297 mm (8.3 x 11.7 in.)	✓	✓	✓
A5 210 x 148 mm (5.8 x 8.3 in.)	✓	✓	X
A5 LEF* 148 x 210 mm (5.8 x 8.3 in.)	✓	✓	X
A6* 105 x 148 mm (4.1 x 5.8 in.)	✓	✓	X
JIS B5 182 x 257 mm (7.2 x 10.1 in.)	✓	✓	X
Oficio (Mexico) 216 x 340 mm (8.5 x 13.4 in.)	✓	✓	✓
Hagaki 100 x 148 mm (3.9 x 5.8 in.)	X	✓	X
Statement 140 x 216 mm (5.5 x 8.5 in.)	✓	✓	X
Executive 184 x 267 mm (7.3 x 10.5 in.)	✓	✓	X
Letter 216 x 279 mm (8.5 x 11 in.)	✓	✓	✓
Legal 216 x 356 mm (8.5 x 14 in.)	✓	✓	✓
Folio 216 x 330 mm (8.5 x 13 in.)	✓	✓	✓
Universal 76.2 x 127 mm (3 x 5 in.) to 216 x 356 mm (8.5 x 14 in.)	✓	✓	X
7 3/4 Envelope (Monarch) 98 x 191 mm (3.9 x 7.5 in.)	X	✓	X
9 Envelope 98 x 225 mm (3.9 x 8.9 in.)	X	✓	X
10 Envelope 105 x 241 mm (4.1 x 9.5 in.)	X	✓	X

* This paper size is not supported in the optional tray.

Paper size	Tray	Multipurpose feeder	Two-sided printing
DL Envelope 110 x 220 mm (4.3 x 8.7 in.)	X	✓	X
C5 Envelope 162 x 229 mm (6.4 x 9 in.)	X	✓	X
B5 Envelope 176 x 250 mm (6.9 x 9.8 in.)	X	✓	X
Other Envelope 76.2 x 127 mm (3 x 5 in.) to 216 x 356 mm (8.5 x 14 in.)	X	✓	X

* This paper size is not supported in the optional tray.

Supported paper types

Paper type	Tray	Multipurpose feeder	Two-sided printing
Plain paper	✓	✓	✓
Card stock	X	✓	X
Transparency	✓	✓	X
Recycled	✓	✓	✓
Paper labels¹	✓	✓	X
Bond²	✓	✓	✓
Letterhead	✓	✓	✓
Preprinted	✓	✓	✓
Colored Paper	✓	✓	✓
Light Paper	✓	✓	✓
Heavy Paper²	✓	✓	✓
Rough/Cotton	✓	✓	✓
Envelope	X	✓	X
Rough envelope	X	✓	X

¹ One-sided paper labels designed for laser printers are supported for occasional use. It is recommended to print 20 or fewer pages of paper labels per month. Vinyl, pharmacy, and two-sided labels are not supported.

² Bond and Heavy Paper are supported in two-sided printing up to 90-g/m² (24-lb) paper weight.

Supported paper weights

	Tray	Multipurpose feeder	Two-sided printing
Paper weight	60–120 g/m ² (16–32 lb)	60–216 g/m ² (16–58 lb)	60–90 g/m ² (16–24 lb)

Printing

Printing from a computer

Note: For labels, card stock, and envelopes, set the paper size and type in the printer before printing the document.

- 1 From the document that you are trying to print, open the Print dialog.
- 2 If necessary, adjust the settings.
- 3 Print the document.

Printing from a mobile device

Printing from a mobile device using Lexmark Mobile Print

Lexmark™ Mobile Print allows you to send documents and images directly to a supported Lexmark printer.

- 1 Open the document, and then send or share the document to Lexmark Mobile Print.

Note: Some third-party applications may not support the send or share feature. For more information, see the documentation that came with the application.

- 2 Select a printer.
- 3 Print the document.

Printing from a mobile device using Google Cloud Print

Google Cloud Print™ is a mobile printing service that allows enabled applications on mobile devices to print to any Google Cloud Print-ready printer.

- 1 From the home screen of your mobile device, launch an enabled application.
- 2 Tap **Print**, and then select a printer.
- 3 Print the document.

Printing from a mobile device using Mopria Print Service

Mopria® Print Service is a mobile printing solution for mobile devices running on Android™ version 4.4 or later. It allows you to print directly to any Mopria-certified printer.

Note: Before printing, make sure that the Mopria Print Service is enabled.

- 1 From the home screen of your mobile device, launch a compatible application.
- 2 Tap **Print**, and then select the printer.
- 3 Send the print job.

Printing from a mobile device using AirPrint

The AirPrint software feature is a mobile printing solution that allows you to print directly from Apple devices to an AirPrint-certified printer.

Notes:

- Make sure that the Apple device and the printer are connected to the same network. If the network has multiple wireless hubs, then make sure that both devices are connected to the same subnet.
- This application is supported only in some Apple devices.

1 From your mobile device, select a document from your file manager or launch a compatible application.

2 Tap  > **Print**.

3 Select a printer, and then adjust the settings, if necessary.

4 Print the document.

Printing a font sample list

1 From the control panel, navigate to:

 > **Reports** >  > **Print** >  > **Print Fonts**

2 Select **PCL Fonts** or **PostScript Fonts**, and then press .

Understanding the printer menus

Menu map

Device	<ul style="list-style-type: none"> • Preferences • Remote Operator Panel • Notifications • Power Management 	<ul style="list-style-type: none"> • Information Sent to Lexmark • Restore Factory Defaults • Maintenance • About This Printer
Print	<ul style="list-style-type: none"> • Layout • Setup • Quality • Job Accounting • XPS 	<ul style="list-style-type: none"> • PDF • PostScript • PCL • HTML • Image
Paper	<ul style="list-style-type: none"> • Tray Configuration 	<ul style="list-style-type: none"> • Media Configuration
Network/Ports	<ul style="list-style-type: none"> • Network Overview • Wireless • Ethernet • TCP/IP • SNMP • IPSec • 802.1x 	<ul style="list-style-type: none"> • LPD Configuration • HTTP/FTP Settings • ThinPrint • USB • Google Cloud Print • Wi-Fi Direct
Reports	<ul style="list-style-type: none"> • Menu Settings Page • Device 	<ul style="list-style-type: none"> • Print • Network
Troubleshooting	<ul style="list-style-type: none"> • Print Quality Test Pages 	

Device

Preferences

Menu item	Description
Display Language [List of languages]	Set the language of the text that appears on the display.
Country/Region [List of countries]	Identify the country or region where the printer is configured to operate.
Run Initial Setup Yes No*	Run the setup wizard.
Note: An asterisk (*) next to a value indicates the factory default setting.	

Menu item	Description
Displayed information Display Text 1 Display Text 2	Specify the information to appear on the home screen.
Date and Time Configure Current Date and Time Manually Set Date and Time Date Format [MM-DD-YYYY*] Time Format [12 hour A.M./P.M.*] Time Zone [GMT*] Network Time Protocol Enable NTP NTP Server	Configure the printer date and time.
Paper Sizes U.S.* Metric	Specify the unit of measurement for paper sizes. Note: The country or region selected in the initial setup wizard determines the initial paper size setting.
Screen Timeout 10–300 (60*)	Set the idle time in seconds before the display shows the home screen, or before the printer logs off a user account automatically.
Note: An asterisk (*) next to a value indicates the factory default setting.	

Remote Operator Panel

Menu item	Description
External VNC Connection Don't Allow* Allow	Connect an external Virtual Network Computing (VNC) client to the remote control panel.
Authentication Type None* Standard Authentication	Set the authentication type when accessing the VNC client server.
VNC Password	Specify the password to connect to the VNC client server. Note: This menu item appears only if Authentication Type is set to Standard Authentication.
Note: An asterisk (*) next to a value indicates the factory default setting.	

Notifications

Menu item	Description
Supplies Show Supply Estimates Show estimates* Do not show estimates	Show the estimated supply status information.
Supplies Display Estimates Pages* Percent	Determine the unit that the printer uses to estimate supply usage and trigger custom notifications when user intervention is required. Note: This menu item appears only in the Embedded Web Server.
Supplies Cartridge Alarm Off Single* Continuous	Set the number of times that the alarm sounds when the toner cartridge is low.
Supplies Custom Supply Notifications	Configure notification settings when the printer requires user intervention. Note: This menu item appears only in the Embedded Web Server.
Error Prevention Jam Assist Off On*	Set the printer to check for jammed paper automatically.
Error Prevention Auto Continue Disabled 5–255 (5*)	Let the printer continue processing or printing a job automatically after clearing certain attendance conditions.
Error Prevention Auto Reboot Auto Reboot Reboot always* Reboot never Reboot when idle	Set the printer to restart when an error occurs.
Error Prevention Auto Reboot Max Auto Reboots 1–20 (2*)	Set the number of automatic reboots that the printer can perform.
Error Prevention Auto Reboot Auto Reboot Window 1–525600 (720*)	Set the number of seconds before the printer performs an automatic reboot.

Note: An asterisk (*) next to a value indicates the factory default setting.

Menu item	Description
Error Prevention Auto Reboot Auto Reboot Counter	Show a read-only information of the reboot counter.
Error Prevention Display Short Paper Error Auto-clear* On	Set the printer to show a message when a short paper error occurs. Note: Short paper refers to the size of the paper loaded.
Error Prevention Page Protect Off* On	Set the printer to process the entire page into the memory before printing it.
Jam Content Recovery Jam Recovery Off On Auto*	Set the printer to reprint jammed pages.
Note: An asterisk (*) next to a value indicates the factory default setting.	

Power Management

Menu item	Description
Sleep Mode Profile Print with Display off Allow printing with display off* Display on when printing	Allow printing with the display turned off.
Timeouts Sleep Mode 1–120 minutes (15*)	Set the idle time before the printer begins operating in Sleep mode.
Timeouts Hibernate Timeout Disabled 1 hour 2 hours 3 hours 6 hours 1 day 2 days 3 days* 1 week 2 weeks 1 month	Set the time before the printer enters Hibernate mode.
Note: An asterisk (*) next to a value indicates the factory default setting.	

Menu item	Description
Timeouts Hibernate Timeout on Connection Hibernate Do Not Hibernate*	Set the printer to Hibernate mode even when an active Ethernet connection exists.
Eco-Mode Off* Energy Energy/Paper Paper	Minimize the use of energy, paper, or specialty media. Note: Setting Eco-Mode to Energy or Paper may affect printer performance, but not print quality.
Note: An asterisk (*) next to a value indicates the factory default setting.	

Information Sent to Lexmark

Menu item	Description
Information Sent to Lexmark Save Supplies and Page Usage (Anonymous) Device Performance (Anonymous) None of the Above*	Send printer usage and performance information to Lexmark. Note: Information Send Time appears only when you select any of the settings in Information Sent to Lexmark, except None of the Above.
Information Send Time Start Time Stop Time	
Note: An asterisk (*) next to a value indicates the factory default setting.	

Restore Factory Defaults

Menu item	Description
Restore Settings Restore all settings Restore printer settings Restore network settings	Restore the printer factory default settings.

Maintenance

Config Menu

Menu item	Description
USB Configuration USB PnP 1* 2	Change the USB driver mode of the printer to improve its compatibility with a personal computer.
USB Configuration USB Speed Full Auto*	Set the USB port to run at full speed and disable its high-speed capabilities.
Tray Configuration Tray Linking Automatic* Off	Set the printer to link the trays that have the same paper type and paper size settings.
Tray Configuration Show Tray Insert Message Off Only for unknown sizes* Always	Show the Tray Insert message.
Tray Configuration A5 Loading Short Edge Long Edge*	Specify the page orientation when loading A5-size paper.
Tray Configuration Paper Prompts Auto* MP Feeder Manual Paper	Set the paper source that the user fills when a prompt to load paper appears. Note: For MP Feeder to appear, set Configure MP to Cassette from the Paper menu.
Tray Configuration Envelope Prompts Auto* MP Feeder Manual Envelope	Set the paper source that the user fills when a prompt to load envelope appears. Note: For MP Feeder to appear, set Configure MP to Cassette from the Paper menu.
Tray Configuration Action for Prompts Prompt user* Continue Use current	Set the printer to resolve paper- or envelope-related change prompts.

Note: An asterisk (*) next to a value indicates the factory default setting.

Menu item	Description
Reports Menu Settings Page Event Log Event Log Summary HealthCheck Statistics	Print reports about printer menu settings, printer events, and event logs.
Supply Usage And Counters Clear Supply Usage History Reset Black Cartridge Counter Reset Black Imaging Unit Counter Reset Maintenance Counter	Reset the supply usage history or the supply page counters after replacing the toner cartridge and imaging unit.
Printer Emulations PPDS Emulation Off* On	Set the printer to recognize and use the PPDS data stream.
Print Configuration Font Sharpening 0–150 (24*)	Set a text point-size value below which the high-frequency screens are used when printing font data. For example, if the value is 24, then all fonts sized 24 points or less use the high-frequency screens.
Print Configuration Print Density Disabled* 1–5 (3*)	Adjust the toner density when printing documents.
Device Operations Quiet Mode Off* On	Set the amount of noise that the printer produces. Note: Enabling this setting slows the printer performance.
Device Operations Panel Menus Enable* Disable	Enable access to the control panel menus.
Device Operations Safe Mode Off* On	Set the printer to operate in a special mode, in which it attempts to continue offering as much functionality as possible, despite known issues. For example, when set to On, and the duplex motor is nonfunctional, the printer performs one-sided printing of the documents even if the job is two-sided printing.
Device Operations Clear Custom Status	Erase user-defined strings for the Default or Alternate custom messages.
Device Operations Clear all remotely-installed messages	Erase messages that were remotely installed.
Note: An asterisk (*) next to a value indicates the factory default setting.	

Out of Service Erase

Menu item	Description
Out of Service Erase Printer Memory Last Sanitized	Show information on when the printer memory was last sanitized.
Out of Service Erase Sanitize all information on nonvolatile memory	Clear all settings and applications that are stored in the printer memory.
Out of Service Erase Erase all printer and network settings	Clear all settings and applications that are stored in the printer and network.

About this Printer

Menu item	Description
Asset Tag	Show the serial number of the printer.
Printer's Location	Identify the printer location. The maximum length is 63 characters.
Contact	Personalize the printer name. The maximum length is 63 characters.

Print

Layout

Menu item	Description
Sides 1-sided* 2-sided	Specify whether to print on one side or two sides of the paper.
Flip Style Long Edge* Short Edge	Determine which side of the paper (long edge or short edge) is bound when performing two-sided printing. Note: Depending on the option selected, the printer automatically offsets each printed information of the page to bind the job correctly.
Blank Pages Print Do Not Print*	Print blank pages that are included in a print job.
Collate Off [1,1,2,2,2] On [1,2,1,2,1,2]*	Keep the pages of a print job stacked in sequence, particularly when printing multiple copies of the job.
Separator Sheets None* Between Copies Between Jobs Between Pages	Insert blank separator sheets when printing.
Note: An asterisk (*) next to a value indicates the factory default setting.	

Menu item	Description
Separator Sheet Source Tray [x] (1*) MP Feeder	Specify the paper source for the separator sheet.
Pages per Side Off* 2 pages per side 3 pages per side 4 pages per side 6 pages per side 9 pages per side 12 pages per side 16 pages per side	Print multiple page images on one side of a sheet of paper.
Pages per Side Ordering Horizontal* Reverse Horizontal Vertical Reverse Vertical	Specify the positioning of multiple page images when using Pages per Side. Note: The positioning depends on the number of page images and their page orientation.
Pages per Side Orientation Auto* Landscape Portrait	Specify the orientation of a multiple-page document when using Pages per Side.
Pages per Side Border None* Solid	Print a border around each page image when using Pages per Side.
Copies 1–9999 (1*)	Specify the number of copies for each print job.
Print Area Normal* Whole Page	Set the printable area on a sheet of paper.
Note: An asterisk (*) next to a value indicates the factory default setting.	

Setup

Menu item	Description
Printer Language PCL Emulation* PS Emulation	Set the printer language. Note: Setting a default printer language does not prevent a software program from sending print jobs that use another printer language.
Note: An asterisk (*) next to a value indicates the factory default setting.	

Menu item	Description
Resource Save Off* On	Set the printer to handle temporary downloads when it receives a job that requires more than the available memory. Notes: <ul style="list-style-type: none"> • Off sets the printer to retain downloads only until memory is needed. Downloads are deleted to process print jobs. • When set to On and the printer runs out of memory, a Memory Full [38] appears on the display but downloads are not deleted.
Print All Order Alphabetical* Oldest First Newest First	Specify the order in which held and confidential jobs are printed when Print All is selected.
Note: An asterisk (*) next to a value indicates the factory default setting.	

Quality

Menu item	Description
Print Resolution 600 dpi* 1200 Image Q 2400 Image Q 1200 dpi 300 dpi	Set the resolution for the text and images on the printed output. Note: Resolution is determined in dots per inch or image quality.
Pixel Boost Off* Fonts Horizontally Vertically Both directions	Enable more pixels to print in clusters for clarity, in order to enhance text and images.
Toner Darkness 1–10 (8*)	Determine the lightness or darkness of text images.
Halftone Normal* Detail	Enhance the printed output to have smoother lines with sharper edges.
Brightness -6 to 6 (0*)	Adjust the brightness of the printed output.
Contrast 0 to 5 (0*)	Adjust the contrast of the printed output.
Gray Correction Off Auto*	Adjust the contrast enhancement applied to images.
Note: An asterisk (*) next to a value indicates the factory default setting.	

Job Accounting

Note: This menu appears only when a printer hard disk is installed.

Menu item	Description
Job Accounting Off* On	Set the printer to create a log of the print jobs that it receives.
Accounting Log Frequency Daily Weekly Monthly*	Specify how often the printer creates a log file.
Log Action at End of Frequency None* E-mail Current Log E-mail & Delete Current Log Post Current Log Post & Delete Current Log	Specify how the printer responds when the frequency threshold expires. Note: The value defined in Accounting Log Frequency determines when this action is triggered.
Log Near Full Level Off* On	Specify the maximum size of the log file before the printer executes the Log Action at Near Full.
Log Action at Near Full None* E-mail Current Log E-mail & Delete Current Log E-mail & Delete Oldest Log Post Current Log Post & Delete Current Log Post & Delete Oldest Log Delete Current Log Delete Oldest Log Delete All But Current Delete All Logs	Specify how the printer responds when the hard disk is nearly full. Note: The value defined in Log Near Full Level determines when this action is triggered.
Log Action at Full None* E-mail & Delete Current Log E-mail & Delete Oldest Log Post & Delete Current Log Post & Delete Oldest Log Delete Current Log Delete Oldest Log Delete All But Current Delete All Logs	Specify how the printer responds when disk usage reaches the maximum limit (100MB).
Note: An asterisk (*) next to a value indicates the factory default setting.	

Menu item	Description
URL to Post Log	Specify where the printer posts job accounting logs.
E-mail Address to Send Logs	Specify the e-mail address to which the printer sends job accounting logs.
Log File Prefix	Specify the prefix for the log file name. Note: The current host name defined in the TCP/IP menu is used as the default log file prefix.
Note: An asterisk (*) next to a value indicates the factory default setting.	

XPS

Menu item	Description
Print Error Pages Off* On	Print a test page that contains information on errors, including XML markup errors.
Minimum Line Width 1–30 (2*)	Set the minimum stroke width of any job printed in 1200 dpi.
Note: An asterisk (*) next to a value indicates the factory default setting.	

PDF

Menu item	Description
Scale To Fit Yes No*	Scale the page content to fit the selected paper size.
Annotations Print Do Not Print*	Specify whether to print annotations in the PDF.
Note: An asterisk (*) next to a value indicates the factory default setting.	

PostScript

Menu item	Description
Print PS Error On Off*	Print a test page that contains the PostScript error.
Minimum Line Width 1–30 (2*)	Set the minimum stroke width of any job printed in 1200 dpi.
Lock PS Startup Mode On Off*	Disable the SysStart file.
Note: An asterisk (*) next to a value indicates the factory default setting.	

Menu item	Description
Wait Timeout Disabled 15–65535 (40*)	Set the printer to wait for additional data before canceling a print job.
Note: An asterisk (*) next to a value indicates the factory default setting.	

PCL

Menu item	Description
Font Source Resident* All	Choose the source which contains the default font selection.
Font Name [List of available fonts]	Select a font from the specified font source.
Symbol Set [List of available symbol set]	Specify the symbol set for each font name. Note: A symbol set is a set of alphabetic and numeric characters, punctuation, and special symbols. Symbol sets support the different languages or specific programs such as math symbols for scientific text.
Pitch 0.08–100 (10*)	Specify the font pitch for scalable monospaced fonts. Note: Pitch refers to the number of fixed-space characters in a horizontal inch of type.
Orientation Portrait* Landscape	Specify the orientation of text and graphics on the page.
Lines per Page 1–255	Specify the number of lines of text for each page printed through the PCL® datastream. Notes: <ul style="list-style-type: none"> • This menu item activates vertical escapement that causes the selected number of requested lines to print between the default margins of the page. • 60 is the U.S. factory default setting. 64 is the international factory default setting.
PCL5 Minimum Line Width 1–30 (2*)	Set the initial minimum stroke width. Notes: <ul style="list-style-type: none"> • Jobs printed in 1200 dpi use the value directly. • Jobs printed in 4800CQ use half the value.
PCLXL Minimum Line Width 1–30 (2*)	
A4 Width 198 mm* 203 mm	Set the width of the logical page on A4-size paper. Note: Logical page is the space on the physical page where data is printed.
Note: An asterisk (*) next to a value indicates the factory default setting.	

Menu item	Description
Auto CR after LF On Off*	Set the printer to perform a carriage return after a line feed control command. Note: Carriage return is a mechanism that commands the printer to move the position of the cursor to the first position on the same line.
Auto LF after CR On Off*	Set the printer to perform a line feed after a carriage return control command.
Tray Renumber Assign MP Feeder Off* None 0–201 Assign Tray [x] Off* None 0–201 Assign Manual Paper Off* None 0–201 Assign Manual Envelope Off* None 0–201	Configure the printer to work with print drivers or applications that use different source assignments for the paper source.
Tray Renumber View Factory Defaults	Show the factory default setting assigned for each paper source.
Tray Renumber Restore Defaults	Return all tray assignments to factory default values.
Print Timeout Disabled 1–255 (90*)	Set the printer to end a print job after it has been idle for the specified amount of time in seconds.
Note: An asterisk (*) next to a value indicates the factory default setting.	

HTML

Menu item	Description
Font Name [List of fonts] (Times*)	Set the font to use for HTML documents.
Font Size 1–255 (12*)	Set the font size to use for HTML documents.
Note: An asterisk (*) next to a value indicates the factory default setting.	

Menu item	Description
Scale 1–400% (100*)	Scale HTML documents.
Orientation Portrait* Landscape	Set the page orientation for HTML documents.
Margin Size 8–255 mm (19*)	Set the page margin for HTML documents.
Backgrounds Do Not Print Print*	Print background information or graphics for HTML documents.
Note: An asterisk (*) next to a value indicates the factory default setting.	

Image

Menu item	Description
Auto Fit Off On*	Select the best available paper size and orientation setting for an image. Note: When set to On, this menu item overrides the scaling and orientation settings for the image.
Invert Off* On	Invert bitonal monochrome images. Note: This menu item does not apply to GIF or JPEG image formats.
Scaling Best Fit* Anchor Top Left Anchor Center Fit Height/Width Fit Height Fit Width	Adjust the image to fit the printable area. Note: When Auto Fit is set to On, Scaling is automatically set to Best Fit.
Orientation Portrait* Landscape Reverse Portrait Reverse Landscape	Specify the orientation of text and graphics on the page.
Note: An asterisk (*) next to a value indicates the factory default setting.	

Paper

Tray Configuration

Menu item	Description
<p>Default Source</p> <ul style="list-style-type: none"> Tray [x] (1*) MP Feeder Manual Paper Manual Envelope 	<p>Set the paper source for all print jobs.</p> <p>Note: Multipurpose Feeder only appears when Configure MP is set to Cassette.</p>
<p>Paper Size/Type</p> <ul style="list-style-type: none"> Tray [x] MP Feeder Manual Paper Manual Envelope 	<p>Specify the paper size or paper type loaded in each paper source.</p>
<p>Substitute Size</p> <ul style="list-style-type: none"> Off Statement/A5 Letter/A4 All Listed* 	<p>Set the printer to substitute a specified paper size if the requested size is not loaded in any paper source.</p> <p>Notes:</p> <ul style="list-style-type: none"> • Off prompts the user to load the required paper size. • Statement/A5 prints A5-size document on statement when loading statement and statement-size jobs on A5 paper size when loading A5. • Letter/A4 prints A4-size document on letter when loading letter and letter-size jobs on A4 paper size when loading letter. • All Listed substitutes Letter/A4.
<p>Configure MP</p> <ul style="list-style-type: none"> Cassette* Manual First 	<p>Set the printer when to pick paper loaded in the multipurpose feeder.</p> <p>Notes:</p> <ul style="list-style-type: none"> • When set to Cassette, the printer treats the multipurpose feeder like a tray. • When set to Manual, the printer treats the multipurpose feeder like a manual feeder. • When set to First, the printer picks paper from the multipurpose feeder until it is empty, regardless of the required paper source or paper size.

Note: An asterisk (*) next to a value indicates the factory default setting.

Media Configuration

Universal Setup

Menu item	Description
Units of Measure Inches Millimeters	Specify the unit of measurement for the universal paper. Note: Inches is the U.S. factory default setting. Millimeters is the international factory default setting.
Portrait Width 3–14.17 inches (8.50*) 76–359.91 mm (216*)	Set the portrait width of the universal paper.
Portrait Height 3–14.17 inches (14*) 76–359.91 mm (356*)	Set the portrait height of the universal paper.
Feed Direction Short Edge* Long Edge	Set the printer to pick paper from the short edge or long edge direction. Note: Long Edge appears only when the longest edge is shorter than the maximum width supported.
Note: An asterisk (*) next to a value indicates the factory default setting.	

Media Types

Menu item	Description
Plain Paper Card Stock Transparency Recycled Labels Bond Envelope Rough Envelope Letterhead Preprinted Colored Paper Light Heavy Rough/Cotton Custom Type [x]	Specify the texture and weight of the paper loaded. Select from the following options: Paper Texture Smooth Normal* Rough Paper Weight Light Normal* Heavy
Note: An asterisk (*) next to a value indicates the factory default setting.	

Network/Ports

Network Overview

Menu item	Description
Active Adapter Auto* Standard Network	Specify how a network is connected.
Network Status	Show the connection status of the printer network.
Display Network Status on Printer On* Off	Show the network status on the display.
Speed, Duplex	Show the speed of the currently active network card.
IPv4	Show the IPv4 address.
All IPv6 Addresses	Show all IPv6 addresses.
Reset Print Server	Reset all active network connections to the printer. Note: This setting removes all network configuration settings.
Network Job Timeout Off On* (90 seconds)	Set the time before the printer cancels a network print job.
Banner Page Off* On	Print a banner page.
Note: An asterisk (*) next to a value indicates the factory default setting.	

Wireless

Note: This menu is available only in printers connected to a Wi-Fi network or printers that have a wireless network adapter.

Menu item	Description
Setup Using Mobile App	Configure the Wi-Fi connection using Lexmark Mobile Assistant.

Menu item	Description
Setup On Printer Panel Choose Network Add Wi-Fi Network Network Name Network Mode Infrastructure Wireless Security Mode Disabled* WEP WPA2/WPA - Personal WPA2 - Personal 802.1x - RADIUS	Configure the Wi-Fi connection using the control panel. Note: 802.1x - RADIUS can be configured only from the Embedded Web Server.
Wi-Fi Protected Setup WPS Auto Detect Off On* Start Push Button Method Start PIN Method	Establish a Wi-Fi network and enable network security. Notes: <ul style="list-style-type: none"> • WPS Auto Detect appears only when the Wireless Security Mode is set to WEP. • Start Push-Button Method connects the printer to a Wi-Fi network when buttons on both the printer and the access point (wireless router) are pressed within a given time. • Start PIN Method connects the printer to a Wi-Fi network when a PIN on the printer is entered into the wireless settings of the access point.
Network Mode BSS Type Infrastructure*	Specify the network mode.
Enable Wi-Fi Direct On Off*	Enable Wi-Fi Direct-capable devices to connect directly to the printer.
Compatibility 802.11b/g/n (2.4GHz)* 802.11a/b/g/n/ac (2.4GHz/5GHz) 802.11a/n/ac (5GHz)	Specify the standard for the Wi-Fi network. Note: 802.11a/b/g/n/ac (2.4GHz/5GHz) and 802.11a/n/ac (5GHz) only appear when a Wi-Fi option is installed.
Wireless Security Mode Disabled* WEP WPA2/WPA-Personal WPA2-Personal 802.1x - RADIUS	Set the security mode for connecting the printer to Wi-Fi devices. Note: 802.1x - RADIUS can be configured only from the Embedded Web Server.
WEP Authentication Mode Auto* Open Shared	Set the type of Wireless Encryption Protocol (WEP) for the printer. Note: This menu item appears only when the Wireless Security Mode is set to WEP.
Set WEP Key	Specify a WEP password for secure Wi-Fi connection.

Menu item	Description
WPA2/WPA Personal AES	Enable Wi-Fi security through Wi-Fi Protected Access (WPA). Note: This menu item appears only when the Wireless Security Mode is set to WPA2/WPA-Personal.
Set Pre-Shared Key	Set the password for secure Wi-Fi connection.
WPA2-Personal AES	Enable Wi-Fi security through WPA2. Note: This menu item appears only when the Wireless Security Mode is set to WPA2-Personal.
802.1x Encryption Mode WPA+ WPA2*	Enable Wi-Fi security through 802.1x standard. Notes: <ul style="list-style-type: none"> • This menu item appears only when the Wireless Security Mode is set to 802.1x - RADIUS. • 802.1x - RADIUS can be configured only from the Embedded Web Server.
IPv4 Enable DHCP On* Off Set Static IP Address IP Address Netmask Gateway	Enable and configure IPv4 settings in the printer.
IPv6 Enable IPv6 On* Off Enable DHCPv6 On Off* Stateless Address Autoconfiguration On* Off DNS Server Address Manually Assigned IPv6 Address Manually Assigned IPv6 Router Address Prefix All IPv6 Addresses All IPv6 Router Addresses	Enable and configure IPv6 settings in the printer.
Network Address UAA LAA	View the network addresses.

Menu item	Description
PCL SmartSwitch Off On*	Set the printer to switch automatically to PCL emulation when a print job requires it, regardless of the default printer language. Note: If PCL SmartSwitch is off, then the printer does not examine incoming data and uses the default printer language specified in the Setup menu.
PS SmartSwitch Off On*	Set the printer to switch automatically to PS emulation when a print job requires it, regardless of the default printer language. Note: If PS SmartSwitch is off, then the printer does not examine incoming data and uses the default printer language specified in the Setup menu.
Job Buffering On Off*	Temporarily store print jobs in the printer hard disk before printing. Note: This menu item appears only when a hard disk is installed.
Mac Binary PS Auto* On Off	Set the printer to process Macintosh binary PostScript print jobs. Notes: <ul style="list-style-type: none"> • On processes raw binary PostScript print jobs. • Off filters print jobs using the standard protocol.

Ethernet

Menu item	Description
Network Speed	Show the speed of an active network adapter.
IPv4 Enable DHCP On* Off	Enable Dynamic Host Configuration Protocol (DHCP). Note: DHCP is a standard protocol that allows a server to dynamically distribute IP addressing and configuration information to clients.
IPv4 Set Static IP Address IP Address Netmask Gateway	Set the static IP address of your printer.
Enable IPv6 On* Off	Configure IPv6 in the printer.
Enable DHCPv6 On Off*	Run DHCPv6 in an IPv6 network.
Stateless Address Autoconfiguration On* Off	Set the network adapter to accept the automatic IPv6 address configuration entries provided by a router.

Note: An asterisk (*) next to a value indicates the factory default setting.

Menu item	Description
DNS Address	Specify the DNS server address, IP address, and the router for IPv6 network.
Manually Assigned IPv6 Address	
Manually Assigned IPv6 Router	
Address Prefix 0–128 (64*)	
All IPv6 Addresses	Show all IP and router addresses used in an IPv6 network.
All IPv6 Router Addresses	
Network Address UAA LAA	Show the printer Media Access Control (MAC) addresses: Locally Administered Address (LAA) and Universally Administered Address (UAA). Note: You can change the printer LAA manually.
PCL SmartSwitch On* Off	Set the printer to switch automatically to PCL emulation when a print job requires it, regardless of the default printer language. Note: If PCL SmartSwitch is off, then the printer does not examine incoming data and uses the default printer language specified in the Setup menu.
PS SmartSwitch On* Off	Set the printer to switch automatically to PS emulation when a print job requires it, regardless of the default printer language. Note: If PS SmartSwitch is off, then the printer does not examine incoming data and uses the default printer language specified in the Setup menu.
Mac Binary PS Auto* On Off	Set the printer to process Macintosh binary PostScript print jobs. Notes: <ul style="list-style-type: none"> • On processes raw binary PostScript print jobs. • Off filters print jobs using the standard protocol.
Energy Efficient Ethernet On* Off	Reduce power consumption when the printer receives no data from the Ethernet network.
Note: An asterisk (*) next to a value indicates the factory default setting.	

TCP/IP

Note: This menu appears only in network printers or printers attached to print servers.

Menu item	Description
Set Hostname	Set the current TCP/IP host name.
Domain Name	Set the domain name.
Allow DHCP/BOOTP to update NTP server Off On*	Allow the DHCP and BOOTP clients to update the NTP settings of the printer.
Note: An asterisk (*) next to a value indicates the factory default setting.	

Menu item	Description
Zero Configuration Name	Specify a service name for the zero configuration network.
Enable Auto IP Off On*	Assign an IP address automatically.
DNS Server Address	Specify the current Domain Name System (DNS) server address.
Backup DNS Address	Specify the backup DNS server addresses.
Backup DNS Address 2	
Backup DNS Address 3	
Domain Search Order	Specify a list of domain names to locate the printer and its resources that reside in different domains on the network.
Enable DDNS Off On*	Update the Dynamic DNS settings.
DDNS TTL 300-31536000 (3600*)	Specify the current DDNS settings.
Default TTL 5-254 (254*)	
DDNS Refresh Time 300-31536000 (604800*)	
Enable mDNS Off On*	Update multicast DNS settings.
WINS Address	Specify a server address for Windows Internet Name Service (WINS).
Enable BOOTP Off* On	Allow the BOOTP to assign a printer IP address.
Restricted Server List	Specify an IP address for the TCP connections. Notes: <ul style="list-style-type: none"> • Use a comma to separate each IP address. • You can add up to 50 IP addresses.
Restricted Server List Options Block All Ports* Block Printing Only Block Printing and HTTP Only	Specify how the IP addresses in the list can access the printer functionality.
MTU 256-1500 (1500*)	Specify a maximum transmission unit (MTU) parameter for the TCP connections.
Raw Print Port 1-65535 (9100*)	Specify a raw port number for printers connected on a network.
Note: An asterisk (*) next to a value indicates the factory default setting.	

Menu item	Description
Outbound Traffic Maximum Speed Off* On	Enable the printer maximum transfer rate.
Enable SSLv2 Off* On	Enable the SSLv2 protocol.
Enable SSLv3 Off* On	Enable the SSLv3 protocol.
Enable TLSv1.0 Off On*	Enable the TLSv1.0 protocol.
Enable TLSv1.1 Off On*	Enable the TLSv1.1 protocol.
SSL Cipher List	Specify the cipher algorithms to use for the SSL or the TLS connections.
Note: An asterisk (*) next to a value indicates the factory default setting.	

SNMP

Note: This menu appears only in network printers or printers that are attached to print servers.

Menu item	Description
SNMP Versions 1 and 2c Enabled Off On* Allow SNMP Set Off On* Enable PPM MIB Off On* SNMP Community	Configure Simple Network Management Protocol (SNMP) versions 1 and 2c to install print drivers and applications.
Note: An asterisk (*) next to a value indicates the factory default setting.	

Menu item	Description
<p>SNMP Version 3</p> <ul style="list-style-type: none"> Enabled Off On* Set Read/Write Credentials <ul style="list-style-type: none"> User Name Password Set Read-only Credentials <ul style="list-style-type: none"> User Name Password Authentication Hash <ul style="list-style-type: none"> MD5 SHA1* Minimum Authentication Level <ul style="list-style-type: none"> No Authentication, No Privacy Authentication, No Privacy Authentication, Privacy* Privacy Algorithm <ul style="list-style-type: none"> DES AES-128* 	<p>Configure SNMP version 3 to install and update the printer security.</p>
<p>Note: An asterisk (*) next to a value indicates the factory default setting.</p>	

IPSec

Note: This menu appears only in network printers or printers that are attached to print servers.

Menu item	Description
<p>Enable IPSec</p> <ul style="list-style-type: none"> Off* On 	<p>Enable Internet Protocol Security (IPSec).</p>
<p>Base Configuration</p> <ul style="list-style-type: none"> Default* Compatibility Secure 	<p>Set the IPSec base configuration.</p> <p>Note: This menu item appears only when Enable IPSec is set to On.</p>
<p>IPSec Device Certificate</p>	<p>Specify an IPSec certificate.</p> <p>Note: This menu item appears only when Base Configuration is set to Compatibility.</p>
<p>Note: An asterisk (*) next to a value indicates the factory default setting.</p>	

Menu item	Description
Pre-Shared Key Authenticated Connections Host [x] Address Key	Configure the authenticated connections of the printer. Note: These menu items appear only when Enable IPsec is set to On.
Certificate Authenticated Connections Host [x] Address[/subnet] Address[/subnet]	
Note: An asterisk (*) next to a value indicates the factory default setting.	

802.1x

Note: This menu appears only in network printers or printers that are attached to print servers.

Menu item	Description
Active Off* On	Let the printer join networks that require authentication before allowing access. Note: To configure the settings of this menu item, access the Embedded Web Server.
Note: An asterisk (*) next to a value indicates the factory default setting.	

LPD Configuration

Note: This menu appears only in network printers or printers that are attached to print servers.

Menu item	Description
LPD Timeout 0–65535 seconds (90*)	Set the time-out value to stop the Line Printer Daemon (LPD) server from waiting indefinitely for hung or invalid print jobs.
LPD Banner Page Off* On	Print a banner page for all LPD print jobs. Note: A banner page is the first page of a print job used as a separator of print jobs and to identify the originator of the print job request.
LPD Trailer Page Off* On	Print a trailer page for all LPD print jobs. Note: A trailer page is the last page of a print job.
LPD Carriage Return Conversion Off* On	Enable carriage return conversion. Note: Carriage return is a mechanism that commands the printer to move the position of the cursor to the first position on the same line.
Note: An asterisk (*) next to a value indicates the factory default setting.	

HTTP/FTP Settings

Note: This menu appears only in network printers or printers attached to print servers.

Menu item	Description
Enable HTTP Server Off On*	Access the Embedded Web Server to monitor and manage the printer.
Enable HTTPS Off On*	Configure the HyperText Transfer Protocol Secure (HTTPS) settings.
Enable FTP/TFTP Off On*	Send files using FTP.
HTTP Default IP Port 1–65535 (80*)	Configure the HTTP and FTP server settings.
HTTPS Device Certificate	
FTP Default IP Port 1–65535 (21*)	
Timeout for HTTP/FTP Requests 1–299 (30*)	Specify the time in seconds before the server connection stops.
Retries for HTTP/FTP Requests 1–299 (3*)	Set the number of retries to connect to the HTTP/FTP server.

Note: An asterisk (*) next to a value indicates the factory default setting.

USB

Menu item	Description
PCL SmartSwitch On* Off	Set the printer to switch to PCL emulation when a print job received through a USB port requires it, regardless of the default printer language. Note: If PCL SmartSwitch is off, then the printer does not examine incoming data and uses the default printer language specified in the Setup menu.
PS SmartSwitch On* Off	Set the printer to switch to PS emulation when a print job received through a USB port requires it, regardless of the default printer language. Note: If PS SmartSwitch is off, then the printer does not examine incoming data and uses the default printer language specified in the Setup menu.
Mac Binary PS Auto* On Off	Set the printer to process Macintosh binary PostScript print jobs. Notes: <ul style="list-style-type: none"> • On processes raw binary PostScript print jobs. • Off filters print jobs using the standard protocol.

Note: An asterisk (*) next to a value indicates the factory default setting.

Menu item	Description
Enable USB Port Enable* Disable	Enable the standard USB port.
Note: An asterisk (*) next to a value indicates the factory default setting.	

ThinPrint

Menu item	Description
Enable ThinPrint Off On*	Print using ThinPrint.
Port Number 4000–4999 (4000*)	Set the port number for the ThinPrint server.
Bandwidth (bits/sec) 0* 100–1000000	Set the speed to transmit data in a ThinPrint environment.
Packet Size (kbytes) 0–64000 (0*)	Set the packet size for data transmission.
Note: An asterisk (*) next to a value indicates the factory default setting.	

Google Cloud Print

Menu item	Description
Registration Register	Register the printer to the Google Cloud Print server.
Options Enable Google Cloud Print Off On*	Print directly from your Google account.
Options Enable Local Discovery Off On*	Allow the registered user and other users on the same subnet to send jobs to the printer locally.
Options Enable SSL Peer Verification Off On*	Verify authenticity of the peer certificate to connect to your Google account.
Note: An asterisk (*) next to a value indicates the factory default setting.	

Menu item	Description
Options Always Print As Image Off* On	Set the printer to process PDF files as an image for faster printing.
Note: An asterisk (*) next to a value indicates the factory default setting.	

Wi-Fi Direct

Note: This menu appears only when a direct Wi-Fi network is the active network.

Menu item	Description
SSID	Specify the service set identifier (SSID) of the Wi-Fi network.
Set Preshared Key	Set the preshared key (PSK) to authenticate and validate users on a Wi-Fi connection.
Show PSK on Setup Page On* Off	Show the PSK on the Network Setup Page.
Group Owner IP Address	Specify the IP address of the group owner.
Auto-Accept Push Button Requests On Off*	Accept requests to connect to the network automatically. Note: Accepting clients automatically is not secured.
Note: An asterisk (*) next to a value indicates the factory default setting.	

Reports

Menu Settings Page

Menu item	Description
Menu Settings Page	Print a report that contains the printer preferences, settings, and configurations.

Device

Menu item	Description
Device Information	Print a report that contains information about the printer.
Device Statistics	Print a report about printer usage and supply status.
Profile List	Print a list of profiles that are stored in the printer.
Asset Report	Print a report that contains the printer serial number and model name.

Print

Menu item	Description
Print Fonts PCL Fonts PostScript Fonts	Print samples and information about the fonts that are available in each printer language.

Network

Menu item	Description
Network Setup Page	Print a page that shows the configured network and wireless settings on the printer. Note: This menu item appears only in network printers or printers connected to print servers.

Troubleshooting

Troubleshooting

Menu item	Description
Print Quality Test Pages	Print sample pages to identify and correct print quality defects.

Printing the Menu Settings Page

- 1 From the control panel, navigate to:



- 2 Select **Menu Settings Page**, and then press .

Securing the printer

Locating the security slot

The printer is equipped with a security lock feature. Attach a security lock compatible with most laptop computers in the location shown to secure the printer in place.







Erasing printer memory

To erase volatile memory or buffered data, turn off the printer.

To erase non-volatile memory or individual settings, device and network settings, security settings, and embedded solutions, do the following:

- 1 From the control panel, navigate to:

 > **Device** >  > **Maintenance** >  > **Out of Service Erase** > 

- 2 Select **Sanitize all information on nonvolatile memory**, and then press .

- 3 To start the job, select **Continue**, and then press .

- 4 Follow the instructions on the display.

Restoring factory default settings

1 From the control panel, navigate to:

 > **Device** >  > **Restore Factory Defaults** >  > **Restore Settings** > 

2 Select **Restore all settings**, and then press .

3 To start the process, navigate to:

RESTORE >  > **Start** > 

For a more comprehensive method of restoring the factory default settings, see [“Erasing printer memory” on page 53](#).

Statement of Volatility

Type of memory	Description
Volatile memory	The printer uses standard random access memory (RAM) to buffer temporarily user data during simple print and copy jobs.
Non-volatile memory	The printer may use two forms of non-volatile memory: EEPROM and NAND (flash memory). Both types are used to store the operating system, printer settings, network information, scanner and bookmark settings, and embedded solutions.
Hard disk memory	Some printers may have a hard disk drive installed. The printer hard disk is designed for printer-specific functionality. The hard disk lets the printer retain buffered user data from complex print jobs, form data, and font data.

Erase the content of any installed printer memory in the following circumstances:

- The printer is decommissioned.
- The printer hard disk is replaced.
- The printer is moved to a different department or location.
- The printer is serviced by someone from outside your organization.
- The printer is removed from your premises for service.
- The printer is sold to another organization.

Disposing of a printer hard disk

- **Degaussing**—Flushes the hard disk with a magnetic field that erases stored data
- **Crushing**—Physically compresses the hard disk to break component parts and render them unreadable
- **Milling**—Physically shreds the hard disk into small metal bits

Note: To guarantee that all data are completely erased, destroy physically each hard disk where data is stored.

Maintaining the printer

Warning—Potential Damage: Failure to maintain optimum printer performance, or to replace parts and supplies, may cause damage to your printer.

Networking

Connecting the printer to a Wi-Fi network

Using the control panel

- 1 From the control panel, navigate to:

 > **Network/Ports** >  > **Wireless** >  > **Setup On Printer Panel** > 

- 2 Follow the instructions on the display.

Note: For Wi-Fi-network-ready printer models, a prompt for Wi-Fi network setup appears during initial setup.

Using Lexmark Mobile Assistant

- 1 Depending on your mobile device, download the Lexmark Mobile Assistant application from either the Google Play™ store or App Store online store.

- 2 From the control panel, navigate to:

 > **Network/Ports** >  > **Wireless** >  > **Setup Using Mobile App** >  > **Continue for Printer ID**
> 

- 3 From your mobile device, launch the application, and then accept the Terms of Use.
- 4 Grant permissions.
- 5 Tap **Start Wi-Fi Setup**, and then select the printer.
- 6 Select a Wi-Fi network, and then enter your credentials.
- 7 Tap **Finish Wi-Fi Setup**.

Connecting the printer to a wireless network using Wi-Fi Protected Setup (WPS)



Before you begin, make sure that:

- The access point (wireless router) is WPS-certified or WPS-compatible. For more information, see the documentation that came with your access point.
- A wireless network adapter is installed in your printer. For more information, see the instructions that came with the adapter.

Using the Push Button method

- 1 From the control panel, navigate to:

 > **Network/Ports** >  > **Wireless** > 

- 2 Select **Wi-Fi Protected Setup**, and then press .
- 3 Select **Start Push Button Method**, and then press .
- 4 Follow the instructions on the display.

Using the personal identification number (PIN) method

- 1 From the control panel, navigate to:

 > **Network/Ports** >  > **Wireless** > 





- 2 Select **Wi-Fi Protected Setup** >  > **Start PIN Method** > .
- 3 Copy the eight-digit WPS PIN.
- 4 Open a web browser, and then type the IP address of your access point in the address field.

Notes:

- View the printer IP address on the printer home screen. The IP address appears as four sets of numbers separated by periods, such as 123.123.123.123.
 - If you are using a proxy server, then temporarily disable it to load the web page correctly.
- 5 Access the WPS settings. For more information, see the documentation that came with your access point.
 - 6 Enter the eight-digit PIN, and then save the changes.

Deactivating the Wi-Fi network

- 1 From the printer control panel, navigate to:

 > **Network/Ports** >  > **Network Overview** >  > **Active Adapter** >  > **Standard Networking** > 

- 2 Follow the instructions on the display.

Cleaning the printer

 **CAUTION—SHOCK HAZARD:** To avoid the risk of electrical shock when cleaning the exterior of the printer, unplug the power cord from the electrical outlet and disconnect all cables from the printer before proceeding.

Notes:

- Perform this task after every few months.
- Damage to the printer caused by improper handling is not covered by the printer warranty.

- 1 Turn off the printer, and then unplug the power cord from the electrical outlet.
- 2 Remove paper from the standard bin and multipurpose feeder.
- 3 Remove any dust, lint, and pieces of paper around the printer using a soft brush or vacuum.
- 4 Wipe the outside of the printer with a damp, soft, lint-free cloth.

Notes:

- Do not use household cleaners or detergents, as they may damage the finish of the printer.
- Make sure that all areas of the printer are dry after cleaning.

- 5 Connect the power cord to the electrical outlet, and then turn on the printer.

 **CAUTION—POTENTIAL INJURY:** To avoid the risk of fire or electrical shock, connect the power cord to an appropriately rated and properly grounded electrical outlet that is near the product and easily accessible.

Ordering parts and supplies

To order parts and supplies in the U.S., contact Lexmark at 1-800-539-6275 for information about Lexmark authorized dealers in your area. In other countries or regions, go to www.lexmark.com or contact the place where you purchased the printer.

Note: All life estimates for printer supplies assume printing on letter- or A4-size plain paper.

Checking the status of parts and supplies

From the control panel, navigate to:

 > **Status/Supplies** >  > **Supplies** > 

Using genuine Lexmark parts and supplies

Your Lexmark printer is designed to function best with genuine Lexmark parts and supplies. Use of third-party supplies or parts may affect the performance, reliability, or life of the printer and its imaging components. It can also affect warranty coverage. Damage caused by the use of third-party parts and supplies is not covered by the warranty. All life indicators are designed to function with Lexmark parts and supplies, and may deliver unpredictable results if third-party parts and supplies are used. Imaging component usage beyond the intended life may damage your Lexmark printer or its associated components.

Ordering a toner cartridge

Notes:

- The estimated cartridge yield is based on the ISO/IEC 19752 standard.
- Extremely low print coverage for extended periods of time may negatively affect actual yield.

Lexmark MS321 and MS421 Return Program toner cartridges

Item	United States and Canada	European Economic Area	Rest of Asia Pacific	Latin America	Rest of Europe, Middle East, and Africa	Australia and New Zealand
Return Program toner cartridge	56F1000	56F2000	56F3000	56F4000	56F5000	56F6000
High yield Return Program toner cartridge	56F1H00	56F2H00	56F3H00	56F4H00	56F5H00	56F6H00
Extra high yield Return Program toner cartridge ¹	56F1X00	56F2X00	56F3X00	56F4X00	56F5X00	56F6X00
High yield Corporate Return Program toner cartridge ²	56F1H0E	56F2H0E	56F3H0E	56F4H0E	56F5H0E	56F6H0E
Extra high yield Corporate Return Program toner cartridge ^{1,2}	56F1X0E	56F2X0E	56F3X0E	56F4X0E	56F5X0E	56F6X0E

¹ Supported only in the Lexmark MS421 printer model.

² Available only for contract-managed printers. For more information, contact your Lexmark representative or system administrator.

Lexmark MS321 and MS421 regular toner cartridges

Item	Worldwide
High yield regular toner cartridge ¹	56F0HA0
Extra high yield regular toner cartridge ²	56F0XA0

¹ Supported only in the Lexmark MS321 printer model.

² Supported only in the Lexmark MS421 printer model.

Lexmark M1242 Return Program toner cartridge

Item	United States, Canada, Australia, and New Zealand	European Economic Area	Rest of Asia Pacific	Latin America
Return Program toner cartridge	24B6885	24B6888	24B6891	24B6894

Lexmark B2338 and B2442 Return Program toner cartridges

Item	United States and Canada	European Economic Area	Rest of Asia Pacific	Latin America	Rest of Europe, Middle East, and Africa	Australia and New Zealand
Return Program toner cartridge	B231000	B232000	B233000	B234000	B235000	B236000
High yield Return Program toner cartridge*	B241H00	B242H00	B243H00	B244H00	B245H00	B246H00

* Supported only in the Lexmark B2442 printer model.

Lexmark B2338 and B2442 regular toner cartridges

Item	Worldwide
Regular toner cartridge ¹	B2300A0
High yield regular toner cartridge ²	B240HA0

¹ Supported only in the Lexmark B2338 printer model.

² Supported only in the Lexmark B2442 printer model.

Ordering an imaging unit

Extremely low print coverage for extended periods of time may cause imaging unit parts to fail before the toner is exhausted.

Item	Part Number
Return Program imaging unit	56F0Z00
Regular imaging unit	56F0ZA0
Corporate Return Program imaging unit*	56F0Z0E

* This imaging unit is available only for contract-managed printers. For more information, contact your Lexmark representative or system administrator.

Configuring supply notifications

- 1 Open a web browser, and then type the printer IP address in the address field.

Notes:

- View the printer IP address on the printer home screen. The IP address appears as four sets of numbers separated by periods, such as 123.123.123.123.

- If you are using a proxy server, then temporarily disable it to load the web page correctly.

- 2 Click **Settings > Device > Notifications**.
- 3 From the Supplies menu, click **Custom Supply Notifications**.
- 4 Select a notification for each supply item.
- 5 Apply the changes.

Replacing parts and supplies

Replacing the toner cartridge

- 1 Open door A.

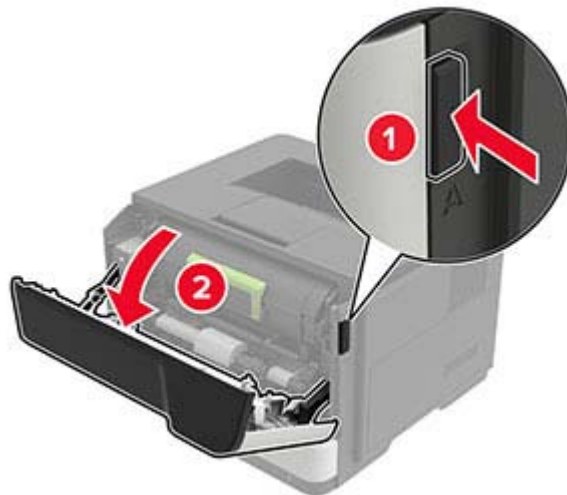

- 2 Remove the used toner cartridge.



- 3 Unpack the new toner cartridge, and then shake it three times to redistribute the toner.



- 4 Insert the new toner cartridge.

Note: Use the arrows inside the printer as guides.



- 5 Close door A.

Replacing the imaging unit

1 Open door A.

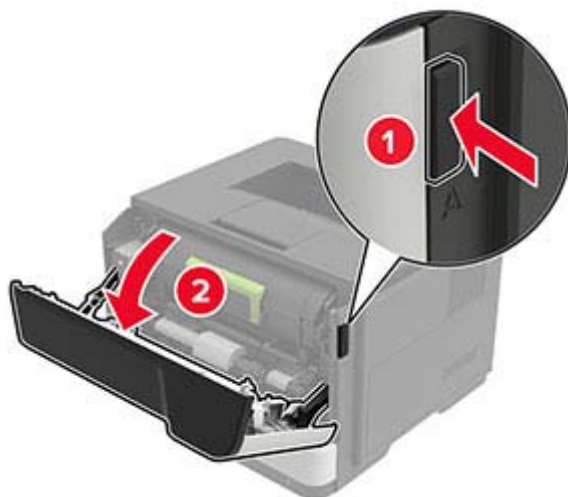

2 Remove the toner cartridge.



3 Remove the used imaging unit.



- 4 Unpack the new imaging unit, and then shake it three times to redistribute the toner.



Warning—Potential Damage: Do not expose the imaging unit to direct light for more than 10 minutes. Extended exposure to light may cause print quality problems.

Warning—Potential Damage: Do not touch the photoconductor drum. Doing so may affect the quality of future print jobs.



- 5 Insert the new imaging unit.

Note: Use the arrows inside the printer as guides.

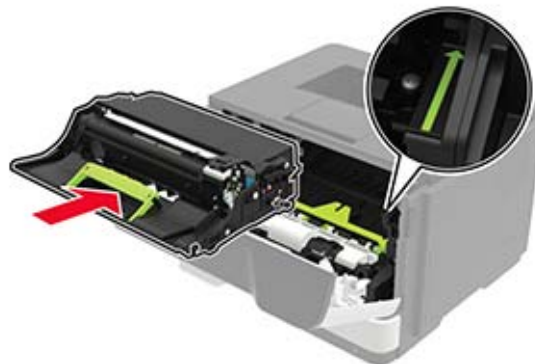

- 6 Insert the toner cartridge.

Note: Use the arrows inside the printer as guides.



7 Close door A.

Replacing the pick tires

- 1 Turn off the printer.
- 2 Unplug the power cord from the electrical outlet, and then from the printer.
- 3 Remove the tray.



4 Remove the used pick tires one after the other.

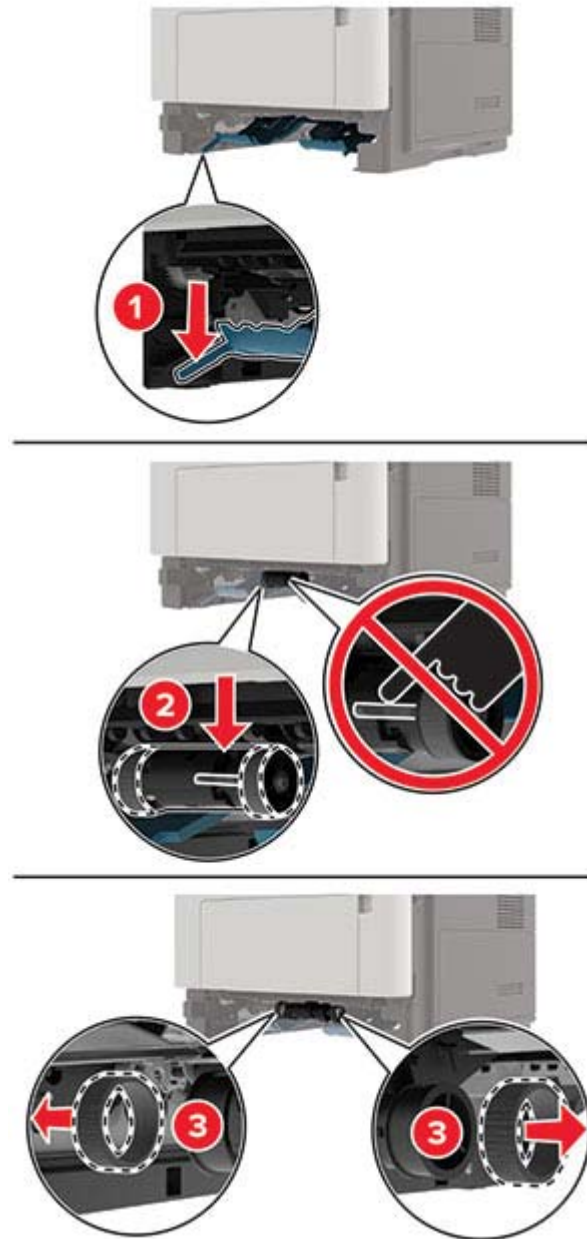

5 Unpack the new pick tires.

- 6 Insert the new pick tires.

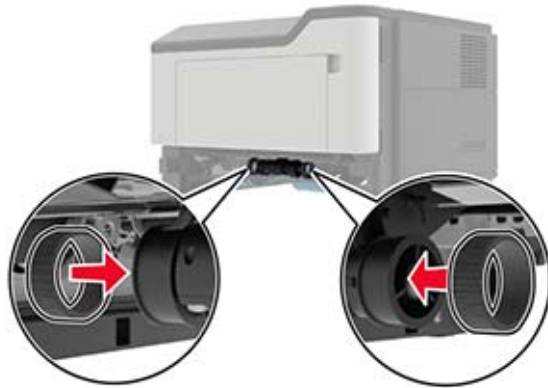

- 7 Insert the tray.
- 8 Connect the power cord to the printer, and then to the electrical outlet.
⚠ CAUTION—POTENTIAL INJURY: To avoid the risk of fire or electrical shock, connect the power cord to an appropriately rated and properly grounded electrical outlet that is near the product and easily accessible.
- 9 Turn on the printer.

Replacing the pick roller assembly

- 1 Turn off the printer.
- 2 Unplug the power cord from the electrical outlet, and then from the printer.
- 3 Remove the optional tray.
⚠ CAUTION—POTENTIAL INJURY: If the printer weight is greater than 20 kg (44 lb), then it may require two or more people to lift it safely.



4 Remove the tray insert, and then flip the tray base.



5 Remove the used pick roller assembly.

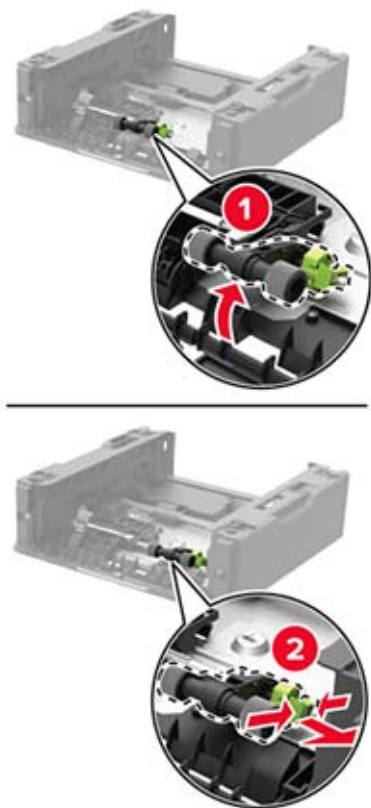

6 Unpack the new pick roller assembly.

7 Insert the new pick roller assembly.



8 Flip the tray base, and then insert the tray insert.

- 9 Align the printer with the optional tray, and then lower the printer until it *clicks* into place.

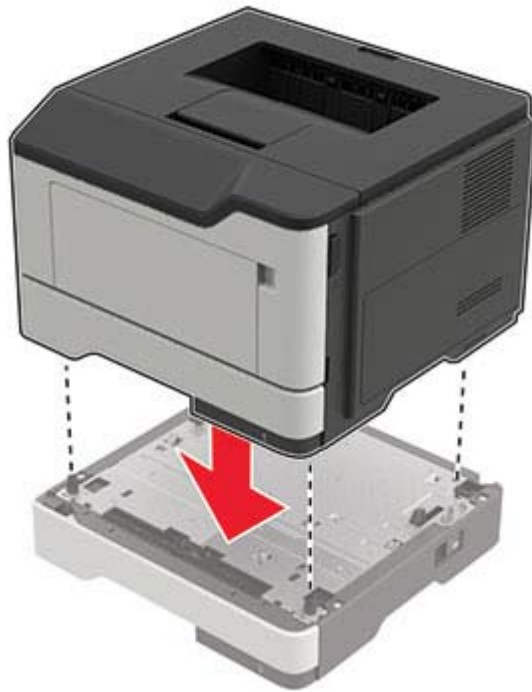

- 10 Connect the power cord to the printer, and then to the electrical outlet.

⚠ CAUTION—POTENTIAL INJURY: To avoid the risk of fire or electrical shock, connect the power cord to an appropriately rated and properly grounded electrical outlet that is near the product and easily accessible.

- 11 Turn on the printer.

Moving the printer

Moving the printer to another location

⚠ CAUTION—POTENTIAL INJURY: If the printer weight is greater than 20 kg (44 lb), then it may require two or more people to lift it safely.

⚠ CAUTION—POTENTIAL INJURY: To avoid the risk of fire or electrical shock, use only the power cord provided with this product or the manufacturer's authorized replacement.

⚠ CAUTION—POTENTIAL INJURY: When moving the printer, follow these guidelines to avoid personal injury or printer damage:

- Make sure that all doors and trays are closed.
- Turn off the printer, and then unplug the power cord from the electrical outlet.
- Disconnect all cords and cables from the printer.
- If the printer has separate floor-standing optional trays or output options attached to it, then disconnect them before moving the printer.

- If the printer has a caster base, then carefully roll it to the new location. Use caution when passing over thresholds and breaks in flooring.
- If the printer does not have a caster base but is configured with optional trays or output options, then remove the output options and lift the printer off the trays. Do not try to lift the printer and any options at the same time.
- Always use the handholds on the printer to lift it.
- Any cart used to move the printer must have a surface able to support the full footprint of the printer.
- Any cart used to move the hardware options must have a surface able to support the dimensions of the options.
- Keep the printer in an upright position.
- Avoid severe jarring movements.
- Make sure that your fingers are not under the printer when you set it down.
- Make sure that there is adequate clearance around the printer.

Note: Damage to the printer caused by improper moving is not covered by the printer warranty.

Shipping the printer

For shipping instructions, go to <http://support.lexmark.com> or contact customer support.

Saving energy and paper

Configuring power save mode settings

Eco-Mode

- 1 From the control panel, navigate to:

 > Device >  > Power Management >  > Eco-Mode > 

- 2 Select a setting.

Sleep mode

- 1 From the control panel, navigate to:

 > Device >  > Power Management >  > Timeouts >  > Sleep Mode > 

- 2 Enter the amount of time that the printer stays idle before it enters Sleep mode.

Hibernate mode

- 1 From the control panel, navigate to:

 > Device >  > Power Management >  > Timeouts >  > Hibernate Timeout > 

- 2 Select the amount of time before the printer enters Hibernate mode.

Notes:

- Make sure to wake the printer from Hibernate mode before sending a print job.
- The Embedded Web Server is disabled when the printer is in Hibernate mode.

Adjusting the brightness of printer display

1 From the control panel, navigate to:



2 Select **Screen Brightness**, and then press **OK**.

3 Adjust the setting, and then press **OK**.

Conserving supplies

- Print on both sides of the paper.
Note: Two-sided printing is the default setting in the print driver.
- Print multiple pages on a single sheet of paper.
- Use the preview feature to see how the document looks like before printing it.
- Print one copy of the document to check its content and format for accuracy.

Recycling

Recycling Lexmark products

To return Lexmark products for recycling:

- 1 Go to www.lexmark.com/recycle.
- 2 Select the product you want to recycle.

Note: Printer supplies and hardware not listed in the Lexmark Collection and Recycling Program may be recycled through your local recycling center.

Recycling Lexmark packaging

Lexmark continually strives to minimize packaging. Less packaging helps to ensure that Lexmark printers are transported in the most efficient and environmentally sensitive manner and that there is less packaging to dispose of. These efficiencies result in fewer greenhouse emissions, energy savings, and natural resource savings. Lexmark also offers recycling of packaging components in some countries or regions. For more information, go to www.lexmark.com/recycle, and then choose your country or region. Information on available packaging recycling programs is included with the information on product recycling.

Lexmark cartons are 100% recyclable where corrugated recycling facilities exist. Facilities may not exist in your area.

The foam used in Lexmark packaging is recyclable where foam recycling facilities exist. Facilities may not exist in your area.

When you return a cartridge to Lexmark, you can reuse the box that the cartridge came in. Lexmark recycles the box.

Clearing jams

Avoiding jams

Load paper properly

- Make sure that the paper lies flat in the tray.

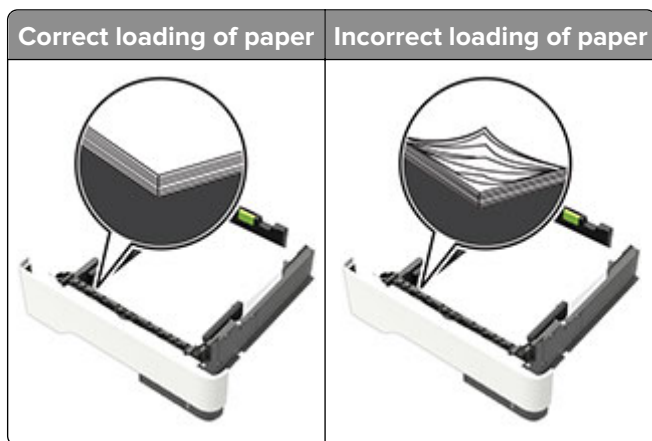

- Do not load or remove a tray while the printer is printing.
- Do not load too much paper. Make sure that the stack height is below the maximum paper fill indicator.
- Do not slide paper into the tray. Load paper as shown in the illustration.

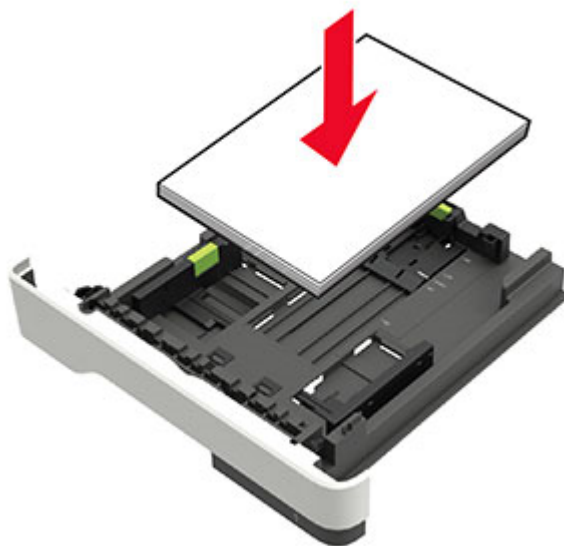

- Make sure that the paper guides are positioned correctly and are not pressing tightly against the paper or envelopes.
- Push the tray firmly into the printer after loading paper.

Use recommended paper

- Use only recommended paper or specialty media.
- Do not load paper that is wrinkled, creased, damp, bent, or curled.

- Flex, fan, and align the paper edges before loading.



- Do not use paper that has been cut or trimmed by hand.
- Do not mix paper sizes, weights, or types in the same tray.
- Make sure that the paper size and type are set correctly on the computer or printer control panel.
- Store paper according to manufacturer recommendations.

Identifying jam locations

Notes:

- When Jam Assist is set to On, the printer automatically flushes blank pages or partially printed pages after a jammed page has been cleared. Check your printed output for blank pages.
- When Jam Recovery is set to On or Auto, the printer reprints jammed pages.

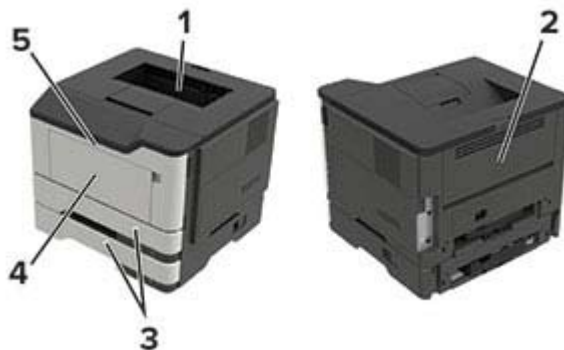

	Jam location
1	Standard bin
2	Rear door
3	Tray [x]
4	Multipurpose feeder
5	Door A

Paper jam in door A

1 Remove the tray.



2 Open door A.

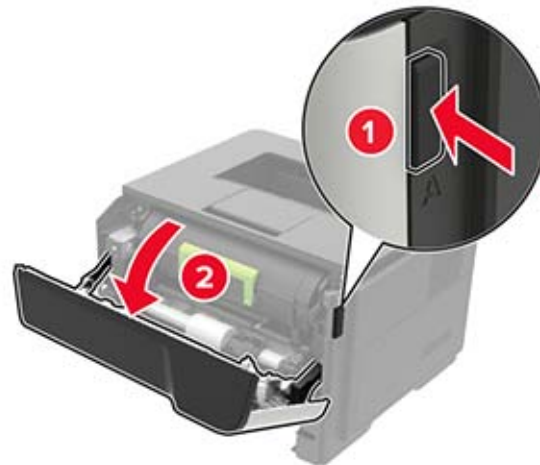

3 Remove the toner cartridge.



4 Remove the imaging unit.

Warning—Potential Damage: Do not expose the imaging unit to direct light for more than 10 minutes. Extended exposure to light may cause print quality problems.

Warning—Potential Damage: Do not touch the photoconductor drum. Doing so may affect the quality of future print jobs.

**5** Remove the jammed paper.

CAUTION—HOT SURFACE: The inside of the printer might be hot. To reduce the risk of injury from a hot component, allow the surface to cool before touching it.

Note: Make sure that all paper fragments are removed.

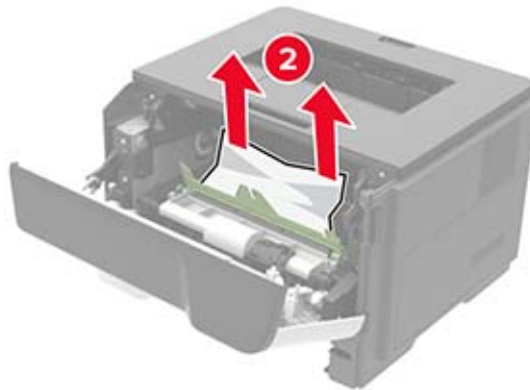
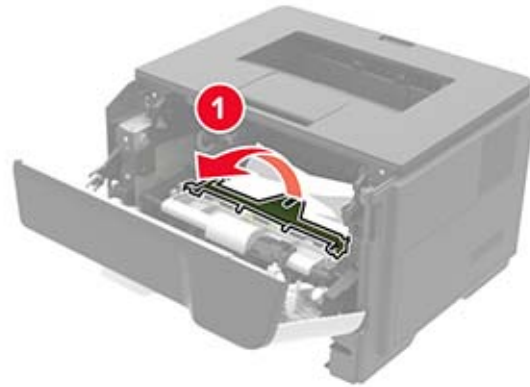

6 Insert the imaging unit.

Note: Use the arrows inside the printer as guides.



7 Insert the toner cartridge.

Note: Use the arrows inside the printer as guides.

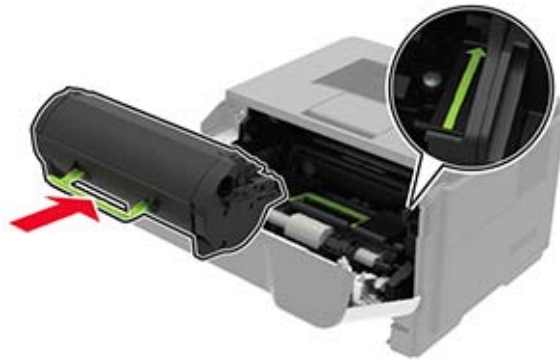

- 8 Close door A.
- 9 Insert the tray.

Paper jam in the rear door

- 1 Open the rear door.

 **CAUTION—HOT SURFACE:** The inside of the printer might be hot. To reduce the risk of injury from a hot component, allow the surface to cool before touching it.

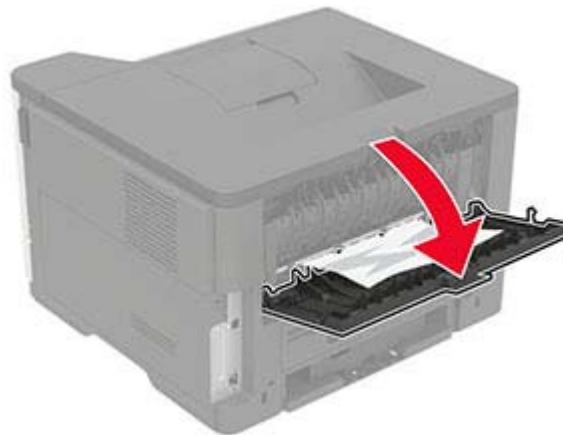

- 2 Remove the jammed paper.

Note: Make sure that all paper fragments are removed.



3 Close the rear door.

Paper jam in the standard bin

Remove the jammed paper.

Note: Make sure that all paper fragments are removed.

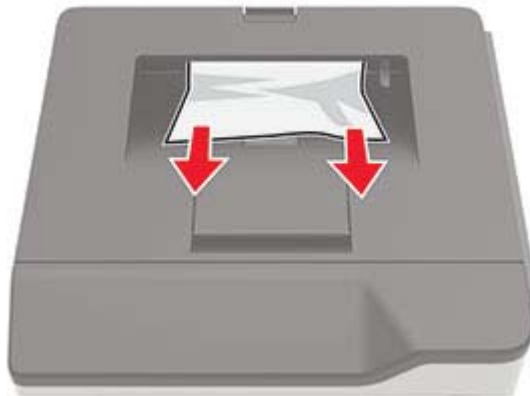

Paper jam in the duplex unit

- 1 Remove the tray.



- 2 Remove the jammed paper.

Note: Make sure that all paper fragments are removed.

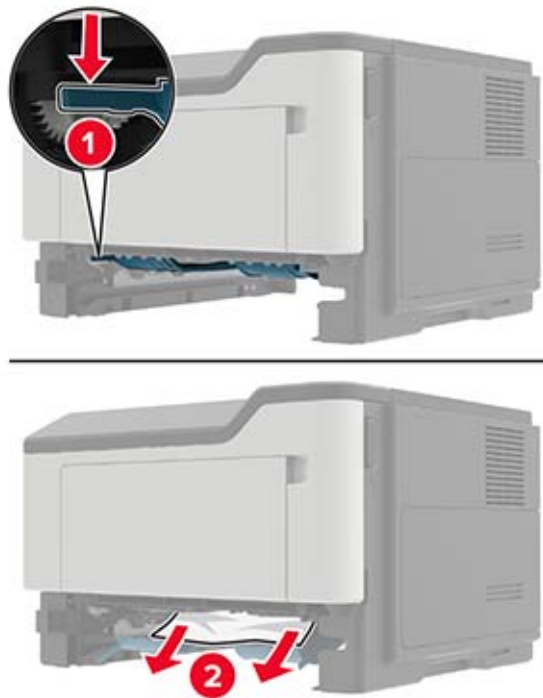

- 3 Insert the tray.

Paper jam in trays

- 1 Remove the tray.



- 2 Remove the jammed paper.

Note: Make sure that all paper fragments are removed.

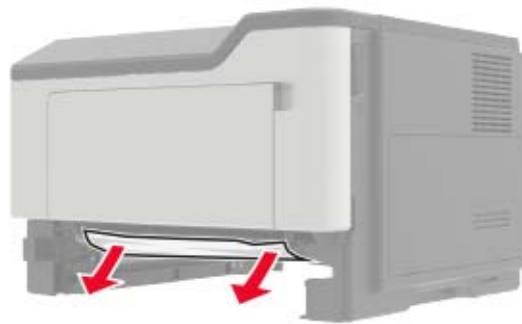

- 3 Insert the tray.

Paper jam in the multipurpose feeder

- 1 Remove paper from the multipurpose feeder.
- 2 Remove the jammed paper.

Note: Make sure that all paper fragments are removed.



3 Flex, fan, and align the paper edges before loading.



4 Reload paper, and then adjust the paper guide.



Troubleshooting

Configuring the SMTP server

1 Open a web browser, and then type the printer IP address in the address field.

Notes:

- View the printer IP address on the printer home screen. The IP address appears as four sets of numbers separated by periods, such as 123.123.123.123.
- If you are using a proxy server, then temporarily disable it to load the web page correctly.

2 Click **Settings > Device > Notifications > E-mail Alerts Setup**.

3 From the E-mail Setup section, configure the settings.

4 Click **Save**.

Network connection problems

Cannot open Embedded Web Server

Action	Yes	No
<p>Step 1 Check if the printer is on.</p> <p>Is the printer on?</p>	Go to step 2.	Turn on the printer.
<p>Step 2 Make sure that the printer IP address is correct. View the printer IP address:</p> <ul style="list-style-type: none"> • From the home screen • From the TCP/IP section in the Network/Ports menu • By printing a network setup page or menu settings page, and then finding the TCP/IP section <p>Note: An IP address appears as four sets of numbers separated by periods, such as 123.123.123.123.</p> <p>Is the printer IP address correct?</p>	Go to step 3.	Type the correct printer IP address in the address field.

Action	Yes	No
<p>Step 3</p> <p>Check if you are using a supported browser:</p> <ul style="list-style-type: none"> • Internet Explorer® version 11 or later • Microsoft Edge™ • Safari version 6 or later • Google Chrome™ version 32 or later • Mozilla Firefox version 24 or later <p>Is your browser supported?</p>	Go to step 4.	Install a supported browser.
<p>Step 4</p> <p>Check if the network connection is working.</p> <p>Is the network connection working?</p>	Go to step 5.	Contact your administrator.
<p>Step 5</p> <p>Make sure that the cable connections to the printer and print server are secure. For more information, see the documentation that came with the printer.</p> <p>Are the cable connections secure?</p>	Go to step 6.	Secure the cable connections.
<p>Step 6</p> <p>Check if the web proxy servers are disabled.</p> <p>Are the web proxy servers disabled?</p>	Go to step 7.	Contact your administrator.
<p>Step 7</p> <p>Access the Embedded Web Server.</p> <p>Did the Embedded Web Server open?</p>	The problem is solved.	Contact customer support .

Checking the printer connectivity

1 From the control panel, navigate to:



2 Select **Network Setup Page**, and then press **OK**.

3 Check the first section of the network setup page, and confirm that the status is connected.

If the status is not connected, then the LAN drop may be inactive, or the network cable may be unplugged or malfunctioning. Contact your administrator for assistance.

Issues with supplies

Replace cartridge, printer region mismatch

To correct this problem, purchase a cartridge with the correct region that matches the printer region, or purchase a worldwide cartridge.

- The first number in the message after 42 indicates the region of the printer.
- The second number in the message after 42 indicates the region of the cartridge.

Printer and toner cartridge regions

Region	Numeric code
Worldwide or Undefined region	0
North America (United States, Canada)	1
European Economic Area, Western Europe, Nordic countries, Switzerland	2
Asia Pacific	3
Latin America	4
Rest of Europe, Middle East, Africa	5
Australia, New Zealand	6
Invalid region	9

Note: To find the region settings of the printer and toner cartridge, print the print quality test pages. From the control panel, navigate to: **Settings > Troubleshooting > Print Quality Test Pages.**

Refilled regular [color] cartridge

The printer has detected a Lexmark Regular cartridge that has been refilled with non-genuine toner by a party other than Lexmark.

Select **OK** to continue.

All printer component life indicators are designed to function with Lexmark supplies and parts and may deliver unpredictable results when using supplies or parts in your Lexmark printer that are remanufactured by parties other than Lexmark.

For more information, see the printer statement of limited warranty.

Non-Lexmark supply

The printer has detected a non-Lexmark supply or part installed in the printer.

Your Lexmark printer is designed to function best with genuine Lexmark supplies and parts. Use of third-party supplies or parts may affect the performance, reliability, or life of the printer and its imaging components.

All life indicators are designed to function with Lexmark supplies and parts and may deliver unpredictable results if third-party supplies or parts are used. Imaging component usage beyond the intended life may damage your Lexmark printer or associated components.

Warning—Potential Damage: Use of third-party supplies or parts can affect warranty coverage. Damage caused by the use of third-party supplies or parts may not be covered by the warranty.

To accept any and all of these risks and to proceed with the use of non-genuine supplies or parts in your printer, from the control panel, press and hold **X** and  simultaneously for 15 seconds.

If you do not want to accept these risks, then remove the third-party supply or part from your printer and install a genuine Lexmark supply or part. For more information, see [“Using genuine Lexmark parts and supplies” on page 57.](#)

If the printer does not print after pressing and holding **X** and  simultaneously for 15 seconds, then reset the supply usage counter.

1 From the control panel, navigate to:

 > **Device** >  > **Maintenance** >  > **Config Menu** >  > **Supply Usage And Counters** > 

2 Select the part or supply that you want to reset, and then select **Start** > .

3 Read the warning message, and then select **Continue** > .





4 Press and hold **X** and  simultaneously for 15 seconds to clear the message.

Note: If you are unable to reset the supply usage counters, then return the item to the place of purchase.





Paper feed problems

Envelope seals when printing





Action	Yes	No
<p>Step 1</p> <p>a Use an envelope that has been stored in a dry environment. Note: Printing on envelopes with high moisture content can seal the flaps.</p> <p>b Send the print job.</p> <p>Does the envelope seal when printing?</p>	Go to step 2.	The problem is solved.

Action	Yes	No
<p>Step 2</p> <p>a Make sure that paper type is set to Envelope. From the control panel, navigate to:</p> <p> > Paper >  > Tray Configuration >  > Paper Size/Type > </p> <p>b Send the print job.</p> <p>Does the envelope seal when printing?</p>	<p>Contact customer support.</p>	<p>The problem is solved.</p>

Collated printing does not work





Action	Yes	No
<p>Step 1</p> <p>a From the control panel, navigate to:</p> <p> > Print >  > Layout > </p> <p>b Select Collate, and then press .</p> <p>c Set Collate to On, and then press .</p> <p>d Print the document.</p> <p>Is the document collated correctly?</p>	<p>The problem is solved.</p>	<p>Go to step 2.</p>
<p>Step 2</p> <p>a From the document that you are trying to print, open the Print dialog, and then select Collate.</p> <p>b Print the document.</p> <p>Is the document collated correctly?</p>	<p>The problem is solved.</p>	<p>Go to step 3.</p>
<p>Step 3</p> <p>a Reduce the number of pages to print.</p> <p>b Print the document.</p> <p>Are the pages collated correctly?</p>	<p>The problem is solved.</p>	<p>Contact customer support.</p>

Tray linking does not work



Action	Yes	No
<p>Step 1</p> <p>a Check if the trays contain the same paper size and paper type.</p> <p>b Check if the paper guides are positioned correctly.</p> <p>c Print the document.</p> <p>Do the trays link correctly?</p>	The problem is solved.	Go to step 2.
<p>Step 2</p> <p>a From the control panel, navigate to:</p> <p> > Paper >  > Tray Configuration >  > Paper Size/Type > </p> <p>b Set the paper size and paper type to match the paper loaded in the linked trays.</p> <p>c Print the document.</p> <p>Do the trays link correctly?</p>	The problem is solved.	Go to step 3.
<p>Step 3</p> <p>a Make sure that Tray Linking is set to Automatic. For more information, see “Linking trays” on page 17.</p> <p>b Print the document.</p> <p>Do the trays link correctly?</p>	The problem is solved.	Contact customer support .

Paper frequently jams

Action	Yes	No
<p>Step 1</p> <p>a Remove the tray.</p> <p>b Check if paper is loaded correctly.</p> <p>Notes:</p> <ul style="list-style-type: none"> • Make sure that the paper guides are positioned correctly. • Make sure that the stack height is below the maximum paper fill indicator. • Make sure to print on recommended paper size and type. <p>c Insert the tray.</p> <p>d Print the document.</p> <p>Do paper jams occur frequently?</p>	Go to step 2.	The problem is solved.

Action	Yes	No
<p>Step 2</p> <p>a From the control panel, navigate to:</p> <p> > Paper >  > Tray Configuration >  > Paper Size/Type > </p> <p>b Set the correct paper size and type.</p> <p>c Print the document.</p> <p>Do paper jams occur frequently?</p>	Go to step 3.	The problem is solved.
<p>Step 3</p> <p>a Load paper from a fresh package.</p> <p>Note: Paper absorbs moisture due to high humidity. Store paper in its original wrapper until you are ready to use it.</p> <p>b Print the document.</p> <p>Do paper jams occur frequently?</p>	Contact customer support .	The problem is solved.

Jammed pages are not reprinted

Action	Yes	No
<p>1 From the control panel, navigate to:</p> <p> > Notifications > </p> <p>2 From the Printer Jam Recovery menu, select On or Auto, and then press .</p> <p>Are the jammed pages reprinted?</p>	The problem is solved.	Contact customer support .

Printing problems

Print quality is poor

Blank or white pages



Note: Before solving the problem, print the Print Quality Test Pages. From the control panel, navigate to **Settings > Troubleshooting > Print Quality Test Pages**. For non-touch-screen printer models, press  to navigate through the settings.

Action	Yes	No
<p>Step 1</p> <p>a Check if the printer is using a genuine and supported Lexmark toner cartridge.</p> <p>Note: If the cartridge is not supported, then install a supported one.</p> <p>b Print the document.</p> <p>Is the printer printing blank or white pages?</p>	Go to step 2.	The problem is solved.
<p>Step 2</p> <p>a Remove any packing material that is left on the imaging unit.</p> <p>1 Remove the toner cartridge, and then remove the imaging unit.</p> <p>Warning—Potential Damage: Do not expose the imaging unit to direct light for more than 10 minutes. Extended exposure to light may cause print quality problems.</p> <p>Warning—Potential Damage: Do not touch the photoconductor drum under the imaging unit. Doing so may affect the quality of future print jobs.</p> <p>2 Check the imaging unit for signs of damage, and replace if necessary.</p> <p>Note: Make sure that the photoconductor drum contact is not bent or out of place.</p> <p>3 Firmly shake the imaging unit to redistribute the toner.</p> <p>4 Insert the imaging unit, and then insert the toner cartridge.</p> <p>b Print the document.</p> <p>Is the printer printing blank or white pages?</p>	Go to step 3.	The problem is solved.
<p>Step 3</p> <p>Check the status of the toner cartridge, and replace if necessary.</p> <p>a From the control panel, navigate to:</p> <p>Status/Supplies > Supplies</p> <p>b Print the document.</p> <p>Is the printer printing blank or white pages?</p>	Contact customer support .	The problem is solved.

Dark print



Note: Before solving the problem, print the Print Quality Test Pages. From the control panel, navigate to **Settings > Troubleshooting > Print Quality Test Pages**. For non-touch-screen printer models, press **OK** to navigate through the settings.

Action	Yes	No
<p>Step 1</p> <p>a Check if the printer is using a genuine and supported Lexmark toner cartridge.</p> <p>Note: If the cartridge is not supported, then install a supported one.</p> <p>b Print the document.</p> <p>Is the print dark?</p>	Go to step 2.	The problem is solved.
<p>Step 2</p> <p>a Turn off the printer, wait for about 10 seconds, and then turn on the printer.</p> <p>b Reduce toner darkness. From the control panel, navigate to: Settings > Print > Quality</p> <p>c Print the document.</p> <p>Is the print dark?</p>	Go to step 3.	The problem is solved.
<p>Step 3</p> <p>a Depending on your operating system, specify the paper type from the Printing Preferences or Print dialog.</p> <p>Notes:</p> <ul style="list-style-type: none"> • Make sure that the setting matches the paper loaded. • You can also change the setting on the printer control panel. <p>b Print the document.</p> <p>Is the print dark?</p>	Go to step 4.	The problem is solved.
<p>Step 4</p> <p>Check if the paper has texture or rough finishes.</p> <p>Are you printing on textured or rough paper?</p>	Go to step 5.	Go to step 6.

Action	Yes	No
<p>Step 5</p> <p>a Replace textured paper with plain paper.</p> <p>b Print the document.</p> <p>Is the print dark?</p>	Go to step 6.	The problem is solved.
<p>Step 6</p> <p>a Load paper from a fresh package.</p> <p>Note: Paper absorbs moisture due to high humidity. Store paper in its original wrapper until you are ready to use it.</p> <p>b Print the document.</p> <p>Is the print dark?</p>	Go to step 7.	The problem is solved.
<p>Step 7</p> <p>a Remove, and then insert the imaging unit.</p> <p>Warning—Potential Damage: Do not expose the imaging unit to direct light for more than 10 minutes. Extended exposure to light may cause print quality problems.</p> <p>Warning—Potential Damage: Do not touch the photoconductor drum under the imaging unit. Doing so may affect the quality of future print jobs.</p> <p>b Print the document.</p> <p>Is the print dark?</p>	Go to step 8.	The problem is solved.
<p>Step 8</p> <p>a Replace the imaging unit.</p> <p>b Print the document.</p> <p>Is the print dark?</p>	Contact customer support .	The problem is solved.

Fine lines are not printed correctly



Note: Before solving the problem, print the Print Quality Test Pages. From the control panel, navigate to **Settings > Troubleshooting > Print Quality Test Pages**. For non-touch-screen printer models, press  to navigate through the settings.

Action	Yes	No
<p>Step 1</p> <p>a Check if the printer is using a genuine and supported Lexmark toner cartridge.</p> <p>Note: If the cartridge is not supported, then install a supported one.</p> <p>b Print the document.</p> <p>Are fine lines not printed correctly?</p>	Go to step 2.	The problem is solved.
<p>Step 2</p> <p>a Adjust the print quality settings.</p> <p>1 From the control panel, navigate to: Settings > Print > Quality > Pixel Boost > Fonts</p> <p>2 Adjust Toner Darkness to 7. From the control panel, navigate to: Settings > Print > Quality</p> <p>b Print the document.</p> <p>Are fine lines not printed correctly?</p>	Contact customer support .	The problem is solved.

Folded or wrinkled paper



Note: Before solving the problem, print the Print Quality Test Pages. From the control panel, navigate to **Settings > Troubleshooting > Print Quality Test Pages**. For non-touch-screen printer models, press  to navigate through the settings.

Action	Yes	No
<p>Step 1</p> <p>a Check if the printer is using a genuine and supported Lexmark toner cartridge.</p> <p>Note: If the cartridge is not supported, then install a supported one.</p> <p>b Print the document.</p> <p>Is the paper folded or wrinkled?</p>	Go to step 2.	The problem is solved.

Action	Yes	No
<p>Step 2</p> <p>a Load paper from a fresh package.</p> <p>Note: Paper absorbs moisture due to high humidity. Store paper in its original wrapper until you are ready to use it.</p> <p>b Print the document.</p> <p>Is the paper folded or wrinkled?</p>	Go to step 3.	The problem is solved.
<p>Step 3</p> <p>a Depending on your operating system, specify the paper type from the Printing Preferences or Print dialog.</p> <p>Notes:</p> <ul style="list-style-type: none"> • Make sure that the setting matches the paper loaded. • You can also change the setting from the printer control panel. <p>b Print the document.</p> <p>Is the paper folded or wrinkled?</p>	Contact customer support .	The problem is solved.

Gray background



Note: Before solving the problem, print the Print Quality Test Pages. From the control panel, navigate to **Settings > Troubleshooting > Print Quality Test Pages**. For non-touch-screen printer models, press  to navigate through the settings.

Action	Yes	No
<p>Step 1</p> <p>a Turn off the printer, wait for 10 seconds, and then turn on the printer.</p> <p>b Increase toner darkness.</p> <p>From the control panel, navigate to: Settings > Print > Quality</p> <p>c Print the document.</p> <p>Does gray background appear on prints?</p>	Go to step 2.	The problem is solved.

Action	Yes	No
<p>Step 2</p> <p>a Check if the printer is using a genuine and supported Lexmark toner cartridge.</p> <p>Note: If the toner cartridge is not supported, then install a supported one.</p> <p>b Print the document.</p> <p>Does gray background appear on prints?</p>	<p>Go to step 3.</p>	<p>The problem is solved.</p>
<p>Step 3</p> <p>a Depending on your operating system, specify the paper type from the Printing Preferences or Print dialog.</p> <p>Notes:</p> <ul style="list-style-type: none"> • Make sure that the setting matches the paper loaded. • You can also change the setting from the printer control panel. <p>b Print the document.</p> <p>Does gray background appear on prints?</p>	<p>Go to step 4.</p>	<p>The problem is solved.</p>
<p>Step 4</p> <p>Check the status of the toner cartridge, and replace if necessary.</p> <p>a From the control panel, navigate to:</p> <p>Status/Supplies > Supplies</p> <p>b Print the document.</p> <p>Does gray background appear on prints?</p>	<p>Go to step 5.</p>	<p>The problem is solved.</p>

Action	Yes	No
<p>Step 5</p> <p>a Remove the imaging unit.</p> <p>Warning—Potential Damage: Do not expose the imaging unit to direct light for more than 10 minutes. Extended exposure to light may cause print quality problems.</p> <p>Warning—Potential Damage: Do not touch the photoconductor drum under the imaging unit. Doing so may affect the quality of future print jobs.</p> <p>b Remove any packing material that is stuck on the imaging unit.</p> <div data-bbox="396 638 786 783" data-label="Image"> </div> <p>Note: Make sure to remove any obstruction between the charge roller and photoconductor drum.</p> <p>c Insert the imaging unit.</p> <p>d Print the document.</p> <p>Does gray background appear on prints?</p>	<p>Go to step 6.</p>	<p>The problem is solved.</p>
<p>Step 6</p> <p>a Replace the imaging unit.</p> <p>b Print the document.</p> <p>Does gray background appear on prints?</p>	<p>Contact customer support.</p>	<p>The problem is solved.</p>

Horizontal light bands



Note: Before solving the problem, print the Print Quality Test Pages. From the control panel, navigate to **Settings > Troubleshooting > Print Quality Test Pages**. For non-touch-screen printer models, press  to navigate through the settings.

Action	Yes	No
<p>a Check if the printer is using a genuine and supported Lexmark toner cartridge.</p> <p>Note: If the cartridge is not supported, then install a supported one.</p> <p>b Print the document.</p> <p>Do horizontal light bands appear on prints?</p>	Contact customer support .	The problem is solved.

Incorrect margins



Action	Yes	No
<p>Step 1</p> <p>a Adjust the paper guides to the correct position for the paper loaded.</p> <p>b Print the document.</p> <p>Are the margins correct?</p>	The problem is solved.	Go to step 2.
<p>Step 2</p> <p>a Depending on your operating system, specify the paper size from the Printing Preferences or Print dialog.</p> <p>Notes:</p> <ul style="list-style-type: none"> • Make sure that the setting matches the paper loaded. • You can also change the setting from the printer control panel. <p>b Print the document.</p> <p>Are the margins correct?</p>	The problem is solved.	Contact customer support .

Light print



Note: Before solving the problem, print the Print Quality Test Pages. From the control panel, navigate to **Settings > Troubleshooting > Print Quality Test Pages**. For non-touch-screen printer models, press **OK** to navigate through the settings.

Action	Yes	No
<p>Step 1</p> <p>a Check if the printer is using a genuine and supported Lexmark toner cartridge.</p> <p>Note: If the cartridge is not supported, then install a supported one.</p> <p>b Print the document.</p> <p>Is the print light?</p>	Go to step 2.	The problem is solved.
<p>Step 2</p> <p>a Turn off the printer, wait for about 10 seconds, and then turn on the printer.</p> <p>b Increase toner darkness. From the control panel, navigate to: Settings > Print > Quality</p> <p>c Print the document.</p> <p>Is the print light?</p>	Go to step 3.	The problem is solved.
<p>Step 3</p> <p>a Depending on your operating system, specify the paper type from the Printing Preferences or Print dialog.</p> <p>Notes:</p> <ul style="list-style-type: none"> • Make sure that the setting matches the paper loaded. • You can also change the setting on the printer control panel. <p>b Print the document.</p> <p>Is the print light?</p>	Go to step 4.	The problem is solved.

Action	Yes	No
<p>Step 4 Check the status of the toner cartridge, and replace if necessary.</p> <ul style="list-style-type: none"> a From the control panel, navigate to: Status/Supplies > Supplies b Print the document. <p>Is the print light?</p>	<p>Go to step 5.</p>	<p>The problem is solved.</p>
<p>Step 5 a Remove the toner cartridge, and then remove the imaging unit.</p> <p>Warning—Potential Damage: Do not expose the imaging unit to direct light for more than 10 minutes. Extended exposure to light can cause print quality problems.</p> <p>Warning—Potential Damage: Do not touch the photoconductor drum under the imaging unit. Doing so may affect the quality of future print jobs.</p> <ul style="list-style-type: none"> b Push either side of the transfer roller, located below the imaging unit, to check if it depresses and bounces back into place. <p> CAUTION—HOT SURFACE: The inside of the printer might be hot. To reduce the risk of injury from a hot component, allow the surface to cool before touching it.</p> <ul style="list-style-type: none"> c If the transfer roller does not depress and bounce back into place, then remove and insert it. <ul style="list-style-type: none"> 1 Pull up one end of the transfer roller and push it down until it <i>clicks</i> into place. 2 If necessary, repeat the step on the other end. d Firmly shake the imaging unit to redistribute the toner, and then insert it. e Insert the toner cartridge. f Turn off the printer, wait for 10 seconds, and then turn on the printer. g Print the document. <p>Is the print light?</p>	<p>Go to step 6.</p>	<p>The problem is solved.</p>
<p>Step 6 a If the issue happens after installing a new maintenance kit, then check whether the transfer roller included with the kit is installed.</p> <p>Note: If necessary, replace the transfer roller.</p> <ul style="list-style-type: none"> b Print the document. <p>Is the print light?</p>	<p>Go to step 7.</p>	<p>The problem is solved.</p>

Action	Yes	No
<p>Step 7 Check the status of the imaging unit. From the control panel, navigate to: Status/Supplies > Supplies</p> <p>Is the imaging unit near End of Life?</p>	Go to step 8.	Contact customer support .
<p>Step 8 a Replace the imaging unit. b Print the document.</p> <p>Is the print light?</p>	Contact customer support .	The problem is solved.

Mottled print and dots



Note: Before solving the problem, print the Print Quality Test Pages. From the control panel, navigate to **Settings > Troubleshooting > Print Quality Test Pages**. For non-touch-screen printer models, press **OK** to navigate through the settings.

Action	Yes	No
<p>Step 1 a Check if the printer is using a genuine and supported Lexmark toner cartridge. Note: If the toner cartridge is not supported, then install a supported one. b Print the document.</p> <p>Is the print mottled?</p>	Go to step 2.	The problem is solved.
<p>Step 2 Check the printer for leaked toner contamination.</p> <p>Is the printer free of leaked toner?</p>	Go to step 4.	Go to step 3.
<p>Step 3 a Replace the toner cartridge. b Print the document.</p> <p>Is the print mottled?</p>	Go to step 4.	The problem is solved.

Action	Yes	No
<p>Step 4</p> <p>Check the status of the imaging unit. From the control panel, navigate to:</p> <p>Status/Supplies > Supplies</p> <p>Is the imaging unit near end of life?</p>	Go to step 5.	Contact customer support .
<p>Step 5</p> <p>a Replace the imaging unit.</p> <p>b Print the document.</p> <p>Is the print mottled?</p>	Contact customer support .	The problem is solved.

Paper curl



Note: Before solving the problem, print the Print Quality Test Pages. From the control panel, navigate to **Settings > Troubleshooting > Print Quality Test Pages**. For non-touch-screen printer models, press **OK** to navigate through the settings.

Action	Yes	No
<p>Step 1</p> <p>a Check if the printer is using a genuine and supported Lexmark toner cartridge.</p> <p>Note: If the cartridge is not supported, then install a supported one.</p> <p>b Print the document.</p> <p>Is the paper curled?</p>	Go to step 2.	The problem is solved.
<p>Step 2</p> <p>a Adjust the guides in the tray to the correct position for the paper loaded.</p> <p>b Print the document.</p> <p>Is the paper curled?</p>	Go to step 3.	The problem is solved.

Action	Yes	No
<p>Step 3</p> <p>a Depending on your operating system, specify the paper size and paper type from the Printing Preferences or Print dialog.</p> <p>Notes:</p> <ul style="list-style-type: none"> • Make sure that the settings match the paper loaded. • You can also change the settings from the printer control panel. <p>b Print the document.</p> <p>Is the paper curled?</p>	Go to step 4.	The problem is solved.
<p>Step 4</p> <p>a Remove paper from the tray, and then turn over the paper.</p> <p>b Print the document.</p> <p>Is the paper curled?</p>	Go to step 5.	The problem is solved.
<p>Step 5</p> <p>a Load paper from a fresh package.</p> <p>Note: Paper absorbs moisture due to high humidity. Store paper in its original wrapper until you are ready to use it.</p> <p>b Print the document.</p> <p>Is the paper curled?</p>	Go to step 6.	The problem is solved.
<p>Step 6</p> <p>a Check if the paper loaded is supported.</p> <p>Note: If paper is not supported, then load a supported paper.</p> <p>b Print the document.</p> <p>Is the paper curled?</p>	Contact customer support .	The problem is solved.

Print crooked or skewed



Note: Before solving the problem, print the Print Quality Test Pages. From the control panel, navigate to **Settings > Troubleshooting > Print Quality Test Pages**. For non-touch-screen printer models, press  to navigate through the settings.

Action	Yes	No
<p>Step 1</p> <p>a Adjust the guides in the tray to the correct position for the paper loaded.</p> <p>b Print the document.</p> <p>Is the print crooked or skewed?</p>	Go to step 2.	The problem is solved.
<p>Step 2</p> <p>a Check if the paper loaded is supported.</p> <p>Note: If paper is not supported, then load a supported paper.</p> <p>b Print the document.</p> <p>Is the print crooked or skewed?</p>	Go to step 3.	The problem is solved.
<p>Step 3</p> <p>a Check the pick tire in the tray for signs of damage and contamination, and replace if necessary.</p> <p>b Print the document.</p> <p>Is the print crooked or skewed?</p>	Contact customer support .	The problem is solved.

Repeating defects



Note: Before solving the problem, print the Print Quality Test Pages. From the control panel, navigate to **Settings > Troubleshooting > Print Quality Test Pages**. For non-touch-screen printer models, press **OK** to navigate through the settings.

Action	Yes	No
<p>Step 1</p> <p>Using the Print Quality Test Pages, check if the distance between the repeating defects is equal to any of the following:</p> <ul style="list-style-type: none"> • 97 mm (3.82 in.) • 47 mm (1.85 in.) • 38 mm (1.5 in.) <p>Does the distance between the repeating defects match any of the measurements?</p>	Go to step 2.	Take note of the distance, and then contact customer support .

Action	Yes	No
<p>Step 2</p> <p>a Replace the imaging unit.</p> <p>b Print the document.</p> <p>Do the repeating defects appear?</p>	<p>Contact customer support.</p>	<p>The problem is solved.</p>

Solid black pages



Note: Before solving the problem, print the Print Quality Test Pages. From the control panel, navigate to **Settings > Troubleshooting > Print Quality Test Pages**. For non-touch-screen printer models, press **OK** to navigate through the settings.

Action	Yes	No
<p>Step 1</p> <p>a Check if the printer is using a genuine and supported Lexmark toner cartridge.</p> <p>Note: If the toner cartridge is not supported, then install a supported one.</p> <p>b Print the document.</p> <p>Is the printer printing solid black pages?</p>	<p>Go to step 2.</p>	<p>The problem is solved.</p>
<p>Step 2</p> <p>a Remove, and then insert the imaging unit.</p> <p>Warning—Potential Damage: Do not expose the imaging unit to direct light for more than 10 minutes. Extended exposure to light may cause print quality problems.</p> <p>Warning—Potential Damage: Do not touch the photoconductor drum under the imaging unit. Doing so may affect the quality of future print jobs.</p> <p>b Print the document.</p> <p>Is the printer printing solid black pages?</p>	<p>Go to step 3.</p>	<p>The problem is solved.</p>

Action	Yes	No
<p>Step 3</p> <p>a Remove the imaging unit.</p> <p>Warning—Potential Damage: Do not expose the imaging unit to direct light for more than 10 minutes. Extended exposure to light may cause print quality problems.</p> <p>Warning—Potential Damage: Do not touch the photoconductor drum under the imaging unit. Doing so may affect the quality of future print jobs.</p> <p>b Remove any packing material that is stuck on the imaging unit.</p>  <p>Note: Make sure to remove any obstruction between the charge roller and photoconductor drum.</p> <p>c Insert the imaging unit.</p> <p>d Print the document.</p> <p>Is the printer printing solid black pages?</p>	<p>Go to step 4.</p>	<p>The problem is solved.</p>
<p>Step 4</p> <p>Check the imaging unit for signs of damage.</p> <p>Is the imaging unit free from damage?</p>	<p>Contact customer support.</p>	<p>Go to step 5.</p>
<p>Step 5</p> <p>a Replace the imaging unit.</p> <p>b Print the document.</p> <p>Is the printer printing solid black pages?</p>	<p>Contact customer support.</p>	<p>The problem is solved.</p>

Text or images cut off



Note: Before solving the problem, print the Print Quality Test Pages. From the control panel, navigate to **Settings > Troubleshooting > Print Quality Test Pages**. For non-touch-screen printer models, press  to navigate through the settings.

Action	Yes	No
<p>Step 1</p> <p>a Check if the printer is using a genuine and supported Lexmark toner cartridge.</p> <p>Note: If the toner cartridge is not supported, then install a supported one.</p> <p>b Print the document.</p> <p>Are text or images cut off?</p>	<p>Go to step 2.</p>	<p>The problem is solved.</p>
<p>Step 2</p> <p>a Remove, and then insert the imaging unit.</p> <p>Warning—Potential Damage: Do not expose the imaging unit to direct light for more than 10 minutes. Extended exposure to light may cause print quality problems.</p> <p>Warning—Potential Damage: Do not touch the photoconductor drum under the imaging unit. Doing so may affect the quality of future print jobs.</p> <p>b Print the document.</p> <p>Are text or images cut off?</p>	<p>Go to step 3.</p>	<p>The problem is solved.</p>
<p>Step 3</p> <p>a Remove the imaging unit.</p> <p>Warning—Potential Damage: Do not expose the imaging unit to direct light for more than 10 minutes. Extended exposure to light may cause print quality problems.</p> <p>Warning—Potential Damage: Do not touch the photoconductor drum under the imaging unit. Doing so may affect the quality of future print jobs.</p> <p>b Remove any packing material that is stuck on the imaging unit.</p> <div data-bbox="396 1373 786 1518" data-label="Image"> </div> <p>Note: Make sure to remove any obstruction between the charge roller and photoconductor drum.</p> <p>c Insert the imaging unit.</p> <p>d Print the document.</p> <p>Are text or images cut off?</p>	<p>Go to step 4.</p>	<p>The problem is solved.</p>

Action	Yes	No
<p>Step 4</p> <p>a Replace the imaging unit.</p> <p>b Print the document.</p> <p>Are text or images cut off?</p>	<p>Contact customer support.</p>	<p>The problem is solved.</p>

Toner easily rubs off



Note: Before solving the problem, print the Print Quality Test Pages. From the control panel, navigate to **Settings > Troubleshooting > Print Quality Test Pages**. For non-touch-screen printer models, press  to navigate through the settings.

Action	Yes	No
<p>Step 1</p> <p>a Check if the printer is using a genuine and supported Lexmark toner cartridge.</p> <p>Note: If the toner cartridge is not supported, then install a supported one.</p> <p>b Print the document.</p> <p>Does the toner easily rub off?</p>	<p>Go to step 2.</p>	<p>The problem is solved.</p>
<p>Step 2</p> <p>a Depending on your operating system, specify the paper type from the Printing Preferences or Print dialog.</p> <p>Notes:</p> <ul style="list-style-type: none"> • Make sure that the setting matches the paper loaded. • You can also change the setting on the printer control panel. <p>b Print the document.</p> <p>Does the toner easily rub off?</p>	<p>Contact customer support.</p>	<p>The problem is solved.</p>

Vertical dark bands



Note: Before solving the problem, print the Print Quality Test Pages. From the control panel, navigate to **Settings > Troubleshooting > Print Quality Test Pages**. For non-touch-screen printer models, press **OK** to navigate through the settings.

Action	Yes	No
<p>Step 1</p> <p>a Check if the printer is using a genuine and supported Lexmark toner cartridge.</p> <p>Note: If the toner cartridge is not supported, then install a supported one.</p> <p>b Print the document.</p> <p>Do vertical dark bands appear on prints?</p>	Go to step 2.	The problem is solved.
<p>Step 2</p> <p>a Remove the toner cartridge, and then remove the imaging unit.</p> <p>Warning—Potential Damage: Do not expose the imaging unit to direct light for more than 10 minutes. Extended exposure to light may cause print quality problems.</p> <p>Warning—Potential Damage: Do not touch the photoconductor drum under the imaging unit. Doing so may affect the quality of future print jobs.</p> <p>b Insert the imaging unit, and then insert the cartridge.</p> <p>c Print the document.</p> <p>Do vertical dark bands appear on prints?</p>	Go to step 3.	The problem is solved.

Action	Yes	No
<p>Step 3</p> <p>a Remove the imaging unit.</p> <p>Warning—Potential Damage: Do not expose the imaging unit to direct light for more than 10 minutes. Extended exposure to light may cause print quality problems.</p> <p>Warning—Potential Damage: Do not touch the photoconductor drum under the imaging unit. Doing so may affect the quality of future print jobs.</p> <p>b Remove any packing material that is stuck on the imaging unit.</p>  <p>Note: Make sure to remove any obstruction between the charge roller and photoconductor drum.</p> <p>c Insert the imaging unit.</p> <p>d Print the document.</p> <p>Do vertical dark bands appear on prints?</p>	<p>Go to step 4.</p>	<p>The problem is solved.</p>
<p>Step 4</p> <p>a Check if a bright light enters the right side of the printer, and move the printer if necessary.</p> <p>b Print the document.</p> <p>Do vertical dark bands appear on prints?</p>	<p>Contact customer support.</p>	<p>The problem is solved.</p>

Vertical dark lines or streaks





Note: Before solving the problem, print the Print Quality Test Pages. From the control panel, navigate to **Settings > Troubleshooting > Print Quality Test Pages**. For non-touch-screen printer models, press **OK** to navigate through the settings.

Action	Yes	No
<p>Step 1</p> <p>a Check if the printer is using a genuine and supported Lexmark toner cartridge.</p> <p>Note: If the toner cartridge is not supported, then install a supported one.</p> <p>b Print the document.</p> <p>Do vertical dark lines or streaks appear on prints?</p>	Go to step 2.	The problem is solved.
<p>Step 2</p> <p>a Remove, and then reinstall the imaging unit.</p> <p>Warning—Potential Damage: Do not expose the imaging unit to direct light for more than 10 minutes. Extended exposure to light can cause print quality problems.</p> <p>Warning—Potential Damage: Do not touch the photoconductor drum under the imaging unit. Doing so may affect the quality of future print jobs.</p> <p>b Print the document.</p> <p>Do vertical dark lines or streaks appear on prints?</p>	Go to step 3.	The problem is solved.
<p>Step 3</p> <p>a Replace the imaging unit.</p> <p>b Print the document.</p> <p>Do vertical dark lines or streaks appear on prints?</p>	Contact customer support .	The problem is solved.

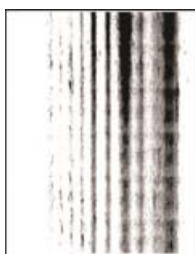
Vertical dark streaks with print missing



Note: Before solving the problem, print the Print Quality Test Pages. From the control panel, navigate to **Settings > Troubleshooting > Print Quality Test Pages**. For non-touch-screen printer models, press  to navigate through the settings.

Action	Yes	No
<p>Step 1</p> <p>a Remove the imaging unit.</p> <p>Warning—Potential Damage: Do not expose the imaging unit to direct light for more than 10 minutes. Extended exposure to light may cause print quality problems.</p> <p>Warning—Potential Damage: Do not touch the photoconductor drum under the imaging unit. Doing so may affect the quality of future print jobs.</p> <p>b Remove any packing material that is stuck on the imaging unit.</p>  <p>Note: Make sure to remove any obstruction between the charge roller and photoconductor drum.</p> <p>c Insert the imaging unit.</p> <p>d Print the document.</p> <p>Do vertical dark streaks with missing images appear on prints?</p>	<p>Go to step 2.</p>	<p>The problem is solved.</p>
<p>Step 2</p> <p>a Check if the printer is using a genuine and supported Lexmark toner cartridge.</p> <p>Note: If the toner cartridge is not supported, then install a supported one.</p> <p>b Print the document.</p> <p>Do vertical dark streaks with missing images appear on prints?</p>	<p>Contact customer support.</p>	<p>The problem is solved.</p>

Vertical light bands



Note: Before solving the problem, print the Print Quality Test Pages. From the control panel, navigate to **Settings > Troubleshooting > Print Quality Test Pages**. For non-touch-screen printer models, press **OK** to navigate through the settings.

Action	Yes	No
<p>a Check if the printer is using a genuine and supported Lexmark toner cartridge.</p> <p>Note: If the cartridge is not supported, then install a supported one.</p> <p>b Print the document.</p> <p>Do vertical light bands appear on prints?</p>	Contact customer support .	The problem is solved.

Vertical white lines



Note: Before solving the problem, print the Print Quality Test Pages. From the control panel, navigate to **Settings > Troubleshooting > Print Quality Test Pages**. For non-touch-screen printer models, press **OK** to navigate through the settings.

Action	Yes	No
<p>Step 1</p> <p>a Check if the printer is using a genuine and supported Lexmark toner cartridge.</p> <p>Note: If the cartridge is not supported, then install a supported one.</p> <p>b Print the document.</p> <p>Do vertical white lines appear on prints?</p>	Go to step 2.	The problem is solved.
<p>Step 2</p> <p>a Depending on your operating system, specify the paper type from the Printing Preferences or Print dialog.</p> <p>Notes:</p> <ul style="list-style-type: none"> • Make sure that the setting matches the paper loaded. • You can also change the setting on the printer control panel. <p>b Print the document.</p> <p>Do vertical white lines appear on prints?</p>	Contact customer support .	The problem is solved.

Slow printing

Action	Yes	No
<p>Step 1</p> <p>a Make sure that the printer is not in Eco-Mode and Quiet Mode.</p> <p>b Print the document.</p> <p>Is the printer still printing slow?</p>	Go to step 2.	The problem is solved.
<p>Step 2</p> <p>a Depending on your operating system, specify the paper type from the Printing Preferences or Print dialog.</p> <p>Notes:</p> <ul style="list-style-type: none"> • Make sure that the setting matches the paper loaded in the tray. • You can also change the setting from the Paper menu on the printer control panel. <p>b Print the document.</p> <p>Is the printer still printing slow?</p>	Go to step 3.	The problem is solved.
<p>Step 3</p> <p>a Reduce the number of pages to print.</p> <p>b Print the document.</p> <p>Is the printer still printing slow?</p>	Go to step 4.	The problem is solved.
<p>Step 4</p> <p>a Connect the printer cable securely to the printer and the computer, print server, option, or other network device.</p> <p>b Print the document.</p> <p>Is the printer still printing slow?</p>	Go to step 5.	The problem is solved.
<p>Step 5</p> <p>a From the Quality menu on the control panel, set Print Resolution to 600 dpi.</p> <p>b Print the document.</p> <p>Is the printer still printing slow?</p>	Go to step 6.	The problem is solved.

Action	Yes	No
<p>Step 6</p> <p>a Make sure that the printer is not overheating.</p> <p>Notes:</p> <ul style="list-style-type: none"> • Allow the printer to cool down after a very long print job. • Observe the recommended ambient temperature for the printer. For more information, see “Selecting a location for the printer” on page 9. <p>b Print the document.</p> <p>Is the printer still printing slow?</p>	Go to step 7.	The problem is solved.
<p>Step 7</p> <p>a Add more printer memory.</p> <p>b Print the document.</p> <p>Is the printer still printing slow?</p>	Contact customer support .	The problem is solved.

Print jobs do not print

Action	Yes	No
<p>Step 1</p> <p>a From the document you are trying to print, open the Print dialog, and then check if you have selected the correct printer.</p> <p>b Print the document.</p> <p>Is the document printed?</p>	The problem is solved.	Go to step 2.
<p>Step 2</p> <p>a Check if the printer is on.</p> <p>b Resolve any error messages that appear on the display.</p> <p>c Print the document.</p> <p>Is the document printed?</p>	The problem is solved.	Go to step 3.
<p>Step 3</p> <p>a Check if the ports are working and if the cables are securely connected to the computer and the printer.</p> <p>For more information, see the setup documentation that came with the printer.</p> <p>b Print the document.</p> <p>Is the document printed?</p>	The problem is solved.	Go to step 4.

Action	Yes	No
<p>Step 4</p> <p>a Turn off the printer, wait for about 10 seconds, and then turn on the printer.</p> <p>b Print the document.</p> <p>Is the document printed?</p>	The problem is solved.	Go to step 5.
<p>Step 5</p> <p>a Remove, and then reinstall the print driver.</p> <p>b Print the document.</p> <p>Is the document printed?</p>	The problem is solved.	Contact customer support .

The printer is not responding

Action	Yes	No
<p>Step 1</p> <p>Check if the power cord is connected to the electrical outlet.</p> <p> CAUTION—POTENTIAL INJURY: To avoid the risk of fire or electrical shock, connect the power cord to an appropriately rated and properly grounded electrical outlet that is near the product and easily accessible.</p> <p>Is the printer responding?</p>	The problem is solved.	Go to step 2.
<p>Step 2</p> <p>Check if the electrical outlet is turned off by a switch or breaker.</p> <p>Is the electrical outlet turned off by a switch or breaker?</p>	Turn on the switch or reset the breaker.	Go to step 3.
<p>Step 3</p> <p>Check if the printer is on.</p> <p>Is the printer on?</p>	Go to step 4.	Turn on the printer.
<p>Step 4</p> <p>Check if the printer is in Sleep or Hibernate mode.</p> <p>Is the printer in Sleep or Hibernate mode?</p>	Press the power button to wake the printer.	Go to step 5.
<p>Step 5</p> <p>Check if the cables connecting the printer and the computer are inserted to the correct ports.</p> <p>Are the cables inserted to the correct ports?</p>	Go to step 6.	Insert the cables to the correct ports.

Action	Yes	No
<p>Step 6</p> <p>Turn off the printer, install the hardware options, and then turn on the printer.</p> <p>For more information, see the documentation that came with the option.</p> <p>Is the printer responding?</p>	The problem is solved.	Go to step 7.
<p>Step 7</p> <p>Install the correct print driver.</p> <p>Is the printer responding?</p>	The problem is solved.	Go to step 8.
<p>Step 8</p> <p>Turn off the printer, wait for about 10 seconds, and then turn on the printer.</p> <p>Is the printer responding?</p>	The problem is solved.	Contact customer support .

Adjusting toner darkness

1 From the control panel, navigate to:







2 Select **Toner Darkness**, and then press **OK**.

3 Adjust the setting, and then press **OK**.

Job prints from the wrong tray or on the wrong paper

Action	Yes	No
<p>Step 1</p> <p>a Check if you are printing on the correct paper.</p> <p>b Print the document.</p> <p>Is the document printed on the correct paper?</p>	Go to step 2.	Load the correct paper size and paper type.

Action	Yes	No
<p>Step 2</p> <p>a Depending on your operating system, specify the paper size and paper type from the Printing Preferences or Print dialog.</p> <p>Note: You can also change the settings on the printer control panel. Navigate to:</p> <p> > Paper >  > Tray Configuration >  > Paper Size/Type > </p> <p>b Make sure that the settings match the paper loaded.</p> <p>c Print the document.</p> <p>Is the document printed on the correct paper?</p>	<p>The problem is solved.</p>	<p>Go to step 3.</p>
<p>Step 3</p> <p>a Check if the trays are linked. For more information, see “Linking trays” on page 17.</p> <p>b Print the document.</p> <p>Is the document printed from the correct tray?</p>	<p>The problem is solved.</p>	<p>Contact customer support.</p>

Contacting customer support

Before contacting customer support, make sure to have the following information:

- Printer problem
- Error message
- Printer model type and serial number

Go to <http://support.lexmark.com> to receive e-mail or chat support, or browse through the library of manuals, support documentation, drivers, and other downloads.

Technical support via telephone is also available. In the U.S. or Canada, call 1-800-539-6275. For other countries or regions, go to <http://support.lexmark.com>.

Upgrading and migrating

Hardware

Available internal options

- User flash
- Font cards

Accessing the controller board



CAUTION—SHOCK HAZARD: To avoid the risk of electrical shock, if you are accessing the controller board or installing optional hardware or memory devices sometime after setting up the printer, then turn the printer off, and unplug the power cord from the electrical outlet before continuing. If you have any other devices attached to the printer, then turn them off as well, and unplug any cables going into the printer.

- 1 Turn off the printer.
- 2 Unplug the power cord from the electrical outlet, and then from the printer.
- 3 Using a flat-head screwdriver, open the controller board access cover.

Warning—Potential Damage: Controller board electronic components are easily damaged by static electricity. Touch a metal surface on the printer before touching any controller board components or connectors.

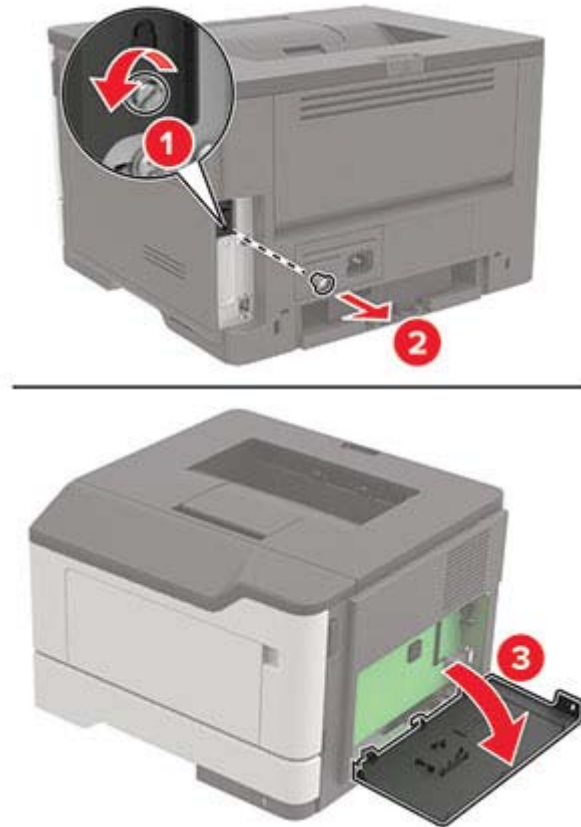

- 4 Close the access cover.
- 5 Connect the power cord to the printer, and then to the electrical outlet.
- 6 Turn on the printer.

Installing a memory card

⚠ CAUTION—SHOCK HAZARD: To avoid the risk of electrical shock, if you are accessing the controller board or installing optional hardware or memory devices sometime after setting up the printer, then turn the printer off, and unplug the power cord from the electrical outlet before continuing. If you have any other devices attached to the printer, then turn them off as well, and unplug any cables going into the printer.

- 1 Turn off the printer.
- 2 Unplug the power cord from the electrical outlet, and then from the printer.
- 3 Open the controller board access cover.

Warning—Potential Damage: Controller board electronic components are easily damaged by static electricity. Touch a metal surface on the printer before touching any controller board components or connectors.

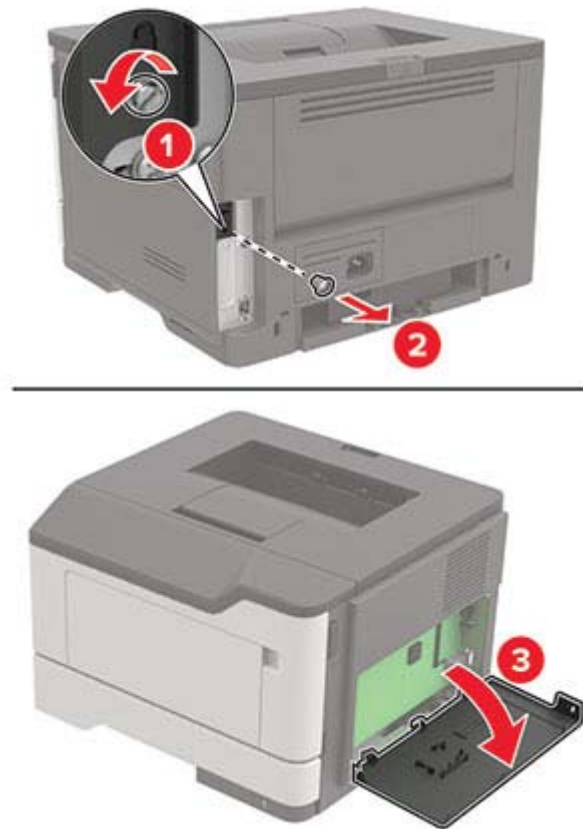

4 Unpack the memory card.

Warning—Potential Damage: Do not touch the connection points along the edge of the card.

5 Insert the memory card until it *clicks* into place.

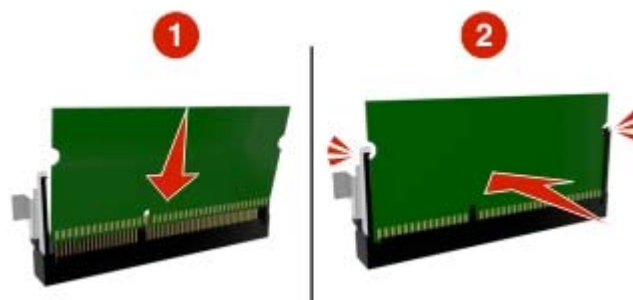

6 Close the controller board access cover.

7 Connect the power cord to the printer, and then to the electrical outlet.

CAUTION—POTENTIAL INJURY: To avoid the risk of fire or electrical shock, connect the power cord to an appropriately rated and properly grounded electrical outlet that is near the product and easily accessible.

8 Turn on the printer.

Installing an optional card

⚠ CAUTION—SHOCK HAZARD: To avoid the risk of electrical shock, if you are accessing the controller board or installing optional hardware or memory devices sometime after setting up the printer, then turn the printer off, and unplug the power cord from the electrical outlet before continuing. If you have any other devices attached to the printer, then turn them off as well, and unplug any cables going into the printer.

- 1 Turn off the printer.
- 2 Unplug the power cord from the electrical outlet, and then from the printer.
- 3 Open the controller board access cover.

Warning—Potential Damage: Controller board electronic components are easily damaged by static electricity. Touch a metal surface on the printer before touching any components or connectors.

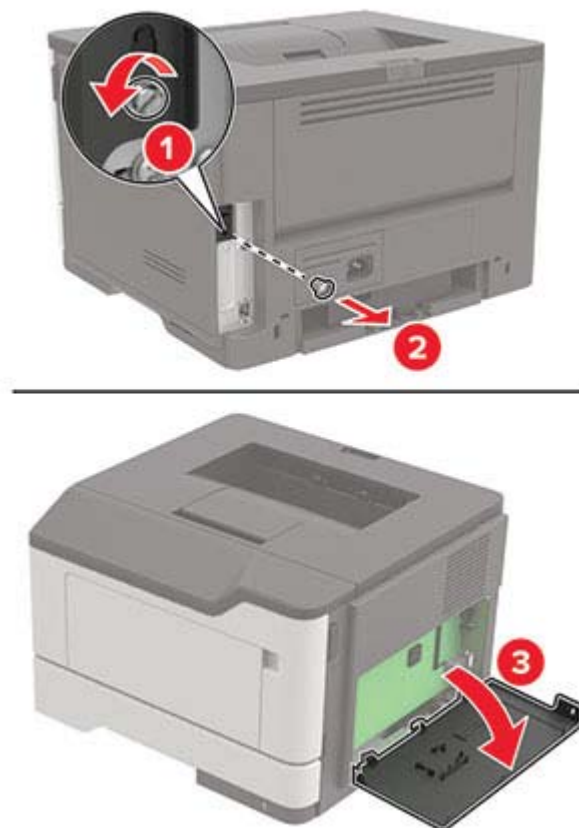

- 4 Unpack the optional card.

Warning—Potential Damage: Do not touch the connection points along the edge of the card.

- 5 Push the card firmly into place.

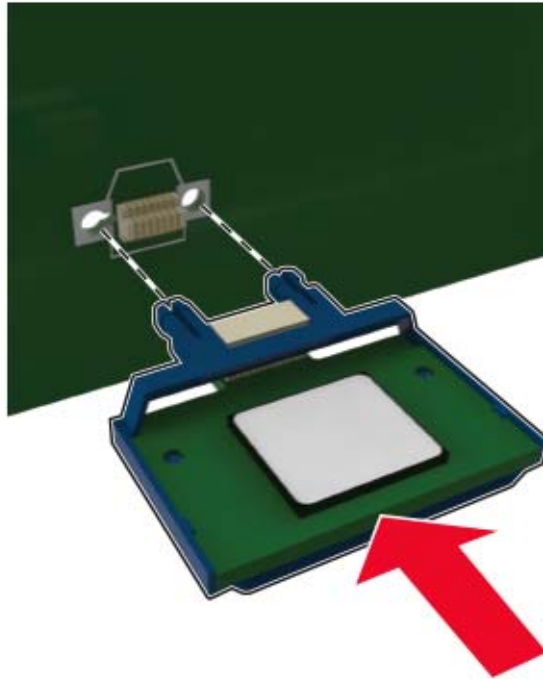

Note: The entire length of the connector on the card must touch and be flush against the controller board.

Warning—Potential Damage: Improper installation of the card may cause damage to the card and the controller board.

- 6 Close the access cover.
- 7 Connect the power cord to the printer, and then to the electrical outlet.

CAUTION—POTENTIAL INJURY: To avoid the risk of fire or electrical shock, connect the power cord to an appropriately rated and properly grounded electrical outlet that is near the product and easily accessible.

- 8 Turn on the printer.

Installing optional trays

CAUTION—SHOCK HAZARD: To avoid the risk of electrical shock, if you are accessing the controller board or installing optional hardware or memory devices sometime after setting up the printer, then turn the printer off, and unplug the power cord from the electrical outlet before continuing. If you have any other devices attached to the printer, then turn them off as well, and unplug any cables going into the printer.

- 1 Turn off the printer.
- 2 Unplug the power cord from the electrical outlet, and then from the printer.

- 3 Unpack the optional tray, and then remove all packing material.

Note: If optional trays are already installed, then unlock them from the printer before lifting the printer. Do not try to lift the printer and trays at the same time.

- 4 Align the printer with the optional tray, and then lower the printer until it *clicks* into place.

 **CAUTION—POTENTIAL INJURY:** If the printer weight is greater than 20 kg (44 lb), then it requires two or more trained personnel to lift it safely.

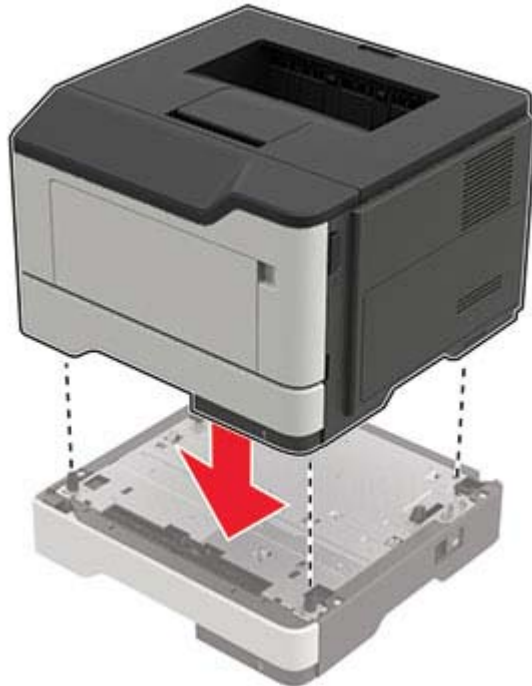

- 5 Connect the power cord to the printer, and then to the electrical outlet.

 **CAUTION—POTENTIAL INJURY:** To avoid the risk of fire or electrical shock, connect the power cord to an appropriately rated and properly grounded electrical outlet that is near the product and easily accessible.

- 6 Turn on the printer.

Add the tray in the print driver to make it available for print jobs. For more information, see [“Adding available options in the print driver”](#) on page 125.

Software

Installing the printer software

- 1 Obtain a copy of the software installer package.
 - From the software CD that came with your printer.
 - Go to <http://support.lexmark.com>, and then select your printer and operating system.
- 2 Run the installer, and then follow the instructions on the computer screen.

- 3 For Macintosh users, add the printer.

Note: Obtain the printer IP address from the TCP/IP section in the Network/Ports menu.

Adding available options in the print driver

For Windows users

- 1 Open the printers folder.
- 2 Select the printer you want to update, and then do either of the following:
 - For Windows 7 or later, select **Printer properties**.
 - For earlier versions, select **Properties**.
- 3 Navigate to the Configuration tab, and then select **Update Now - Ask Printer**.
- 4 Apply the changes.

For Macintosh users

- 1 From System Preferences in the Apple menu, navigate to your printer, and then select **Options & Supplies**.
- 2 Navigate to the list of hardware options, and then add any installed options.
- 3 Apply the changes.

Firmware

Exporting or importing a configuration file

You can export the configuration settings of your printer into a text file, and then import the file to apply the settings to other printers.

- 1 Open a web browser, and then type the printer IP address in the address field.

Notes:

- View the printer IP address on the printer home screen. The IP address appears as four sets of numbers separated by periods, such as 123.123.123.123.
- If you are using a proxy server, then temporarily disable it to load the web page correctly.

- 2 Export or import a configuration file for one or multiple applications.

For one application

- a From the Embedded Web Server, click **Apps** > the application that you want > **Configure**.
- b Click **Export** or **Import**.

For multiple applications

- a From the Embedded Web Server, click **Export Configuration** or **Import Configuration**.
- b Follow the instructions on the screen.

Updating firmware

Updating the firmware using the control panel

Using the notification center

This method is applicable only in some printer models.

- 1 From the control panel, navigate to the notification center, and then select **Firmware update available**.

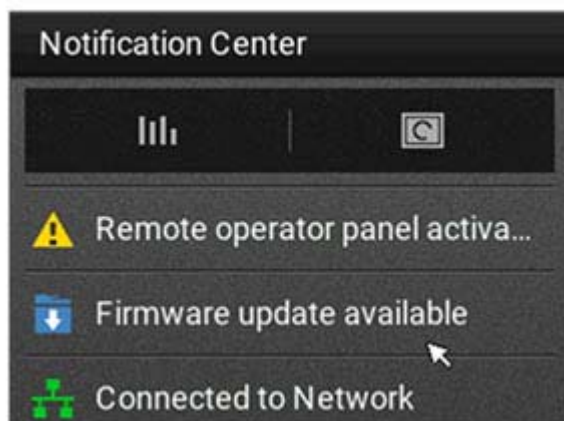

- 2 Select **Install now**.



The printer reboots automatically after the update.

Using the Settings menu

- 1 From the control panel, navigate to **Settings > Device > Update Firmware**.
- 2 Depending on your printer model, select **Check for updates** or **Check for updates now**.
- 3 If a new update is available, then select **Install now**.

The printer reboots automatically after the update.

Updating the firmware using the Embedded Web Server

Before you begin, make sure that:

- You have downloaded the latest printer firmware from <https://support.lexmark.com> and saved it to your flash drive or computer.

Note: To deploy the printer firmware, extract the .fls firmware file from the ZIP package.

- You are not using a special code on your printer to avoid losing this functionality.

Warning—Potential Damage: Make sure that all printers receiving firmware updates are turned on during the entire firmware update process. Turning off a printer during a firmware update can severely damage it.

If the printer is connected to the network when checking for updates, then downloading the firmware is not required.

- 1 Open a web browser, and then type the printer IP address in the address field.

Notes:

- View the printer IP address on the printer home screen. The IP address appears as four sets of numbers separated by periods, such as 123.123.123.123.
- If you are using a proxy server, then temporarily disable it to load the web page correctly.

- 2 Click **Device**.

- 3 Scroll down, and then click **Update Firmware**.

- 4 Depending on your printer model, click **Check for updates** or **Check for updates now**.

If a new update is available, then click **I agree, start update**.

The printer reboots automatically after the update.

Notices

Product information

Product name:

Lexmark B2338dw, Lexmark B2442dw, Lexmark M1242, Lexmark MS321dn; Lexmark MS421dn, Lexmark MS421dw printers

Machine type:

4600

Model(s):

230, 238, 430, 438, 490

Edition notice

March 2024

The following paragraph does not apply to any country where such provisions are inconsistent with local law: LEXMARK INTERNATIONAL, INC., PROVIDES THIS PUBLICATION "AS IS" WITHOUT WARRANTY OF ANY KIND, EITHER EXPRESS OR IMPLIED, INCLUDING, BUT NOT LIMITED TO, THE IMPLIED WARRANTIES OF MERCHANTABILITY OR FITNESS FOR A PARTICULAR PURPOSE. Some states do not allow disclaimer of express or implied warranties in certain transactions; therefore, this statement may not apply to you.

This publication could include technical inaccuracies or typographical errors. Changes are periodically made to the information herein; these changes will be incorporated in later editions. Improvements or changes in the products or the programs described may be made at any time.

References in this publication to products, programs, or services do not imply that the manufacturer intends to make these available in all countries in which it operates. Any reference to a product, program, or service is not intended to state or imply that only that product, program, or service may be used. Any functionally equivalent product, program, or service that does not infringe any existing intellectual property right may be used instead. Evaluation and verification of operation in conjunction with other products, programs, or services, except those expressly designated by the manufacturer, are the user's responsibility.

For Lexmark technical support, go to <http://support.lexmark.com>.

For information on Lexmark's privacy policy governing the use of this product, go to www.lexmark.com/privacy.

For information on supplies and downloads, go to www.lexmark.com.

© 2018 Lexmark International, Inc.

All rights reserved.

GOVERNMENT END USERS

The Software Program and any related documentation are "Commercial Items," as that term is defined in 48 C.F.R. 2.101, "Computer Software" and "Commercial Computer Software Documentation," as such terms are used in 48 C.F.R. 12.212 or 48 C.F.R. 227.7202, as applicable. Consistent with 48 C.F.R. 12.212 or 48 C.F.R. 227.7202-1 through 227.7207-4, as applicable, the Commercial Computer Software and Commercial Software

Documentation are licensed to the U.S. Government end users (a) only as Commercial Items and (b) with only those rights as are granted to all other end users pursuant to the terms and conditions herein.

Trademarks

Lexmark and the Lexmark logo are trademarks or registered trademarks of Lexmark International, Inc. in the United States and/or other countries.

Google Cloud Print and Google Chrome are trademarks of Google Inc. Android and Google Play are trademarks of Google LLC.

Macintosh, Mac, App Store, and Safari are trademarks of Apple Inc. AirPrint and the AirPrint logo are trademarks of Apple, Inc.

Microsoft, Windows, and Internet Explorer are either registered trademarks or trademarks of the Microsoft group of companies in the United States and other countries.

Mopria®, the Mopria® logo, and the Mopria® Alliance logo are registered trademarks and service marks of Mopria Alliance, Inc. in the United States and other countries. Unauthorized use is strictly prohibited.

PCL® is a registered trademark of the Hewlett-Packard Company. PCL is Hewlett-Packard Company’s designation of a set of printer commands (language) and functions included in its printer products. This printer is intended to be compatible with the PCL language. This means the printer recognizes PCL commands used in various application programs, and that the printer emulates the functions corresponding to the commands.

PostScript is a registered trademark of Adobe Systems Incorporated in the United States and/or other countries.

All other trademarks are the property of their respective owners.

Licensing notices

All licensing notices associated with this product can be viewed from the CD:\NOTICES directory of the installation software CD.

Noise emission levels

The following measurements were made in accordance with ISO 7779 and reported in conformance with ISO 9296.

Note: Some modes may not apply to your product.

1-meter average sound pressure, dBA	
Printing	One-sided: 54 (MS321, B2338), 55 (MS421, M1242, B2442); Two-sided: 53 (MS321, B2338), 54 (MS421, M1242, B2442)
Scanning	N/A
Copying	N/A
Ready	14

Values are subject to change. See www.lexmark.com for current values.

Waste from Electrical and Electronic Equipment (WEEE) directive



The WEEE logo signifies specific recycling programs and procedures for electronic products in countries of the European Union. We encourage the recycling of our products.

If you have further questions about recycling options, visit the Lexmark Web site at www.lexmark.com for your local sales office phone number.

India E-Waste notice



This product complies with the India E-Waste (Management and Handling) Rules, 2011, which prohibit use of lead, mercury, hexavalent chromium, polybrominated biphenyls, or polybrominated diphenyl ethers in concentrations exceeding 0.1% by weight and 0.01% by weight for cadmium, except for the exemption set in Schedule II of the Rules.

Product disposal

Do not dispose of the printer or supplies in the same manner as normal household waste. Consult your local authorities for disposal and recycling options.

Returning Lexmark cartridges for reuse or recycling

The Lexmark Cartridge Collection Program allows you to return used cartridges for free to Lexmark for reuse or recycling. One hundred percent of the empty cartridges returned to Lexmark are either reused or demanufactured for recycling. The boxes used to return the cartridges are also recycled.

To return Lexmark cartridges for reuse or recycling, do the following:

- 1 Go to www.lexmark.com/recycle.
- 2 Select the product that you want to recycle.

Static sensitivity notice



This symbol identifies static-sensitive parts. Do not touch the areas near these symbols without first touching a metal surface in an area away from the symbol.

To prevent damage from electrostatic discharge when performing maintenance tasks such as clearing paper jams or replacing supplies, touch any exposed metal frame of the printer before accessing or touching interior areas of the printer even if the symbol is not present.

ENERGY STAR

Any Lexmark product bearing the ENERGY STAR® emblem on the product or on a start-up screen is certified to comply with Environmental Protection Agency (EPA) ENERGY STAR requirements as of the date of manufacture.



Temperature information

Ambient operating temperature	10 to 32°C (50 to 90°F)
Shipping temperature	-20 to 40°C (-4 to 104°F)
Storage temperature and relative humidity	0 to 40°C (32 to 104°F) 8 to 80% RH

Laser notice

The printer is certified in the U.S. to conform to the requirements of DHHS 21 CFR, Chapter I, Subchapter J for Class I (1) laser products, and elsewhere is certified as a Class I laser product conforming to the requirements of IEC 60825-1: 2014.

Class I laser products are not considered to be hazardous. The printer contains internally a Class IIIb (3b) AlGaInP laser that is nominally 15 milliwatts operating in the wavelength region of 650–670 nanometers and enclosed in a non-serviceable printhead assembly. The laser system and printer are designed so there is never any human access to laser radiation above a Class I level during normal operation, user maintenance, or prescribed service conditions.

Power consumption

Product power consumption

The following table documents the power consumption characteristics of the product.

Note: Some modes may not apply to your product.

Mode	Description	Power consumption (Watts)
Printing	The product is generating hard-copy output from electronic inputs.	One-sided: 520 (MS321, B2338), 570 (MS421, M1242, B2442); Two-sided: 315 (MS321, B2338), 345 (MS421, M1242, B2442)
Copy	The product is generating hard-copy output from hard-copy original documents.	N/A
Scan	The product is scanning hard-copy documents.	N/A
Ready	The product is waiting for a print job.	7 (MS321, B2338), 7.5 (MS421, M1242, B2442)
Sleep Mode	The product is in a high-level energy-saving mode.	1.19 (MS321, B2338), 1.56 (MS421, M1242, B2442)
Hibernate	The product is in a low-level energy-saving mode.	0.1
Off	The product is plugged into an electrical outlet, but the power switch is turned off.	0.1

The power consumption levels listed in the previous table represent time-averaged measurements. Instantaneous power draws may be substantially higher than the average.

Values are subject to change. See www.lexmark.com for current values.

Sleep Mode

This product is designed with an energy-saving mode called *Sleep Mode*. The Sleep Mode saves energy by lowering power consumption during extended periods of inactivity. The Sleep Mode is automatically engaged after this product is not used for a specified period of time, called the *Sleep Mode Timeout*.

Factory default Sleep Mode Timeout for this product (in minutes):	15
---	----

By using the configuration menus, the Sleep Mode Timeout can be modified between 1 minute and 120 minutes. If the print speed is less than or equal to 30 pages per minute, then you can set the timeout only up to 60 minutes. Setting the Sleep Mode Timeout to a low value reduces energy consumption, but may increase the response time of the product. Setting the Sleep Mode Timeout to a high value maintains a fast response, but uses more energy.

Hibernate Mode

This product is designed with an ultra-low power operating mode called *Hibernate mode*. When operating in Hibernate Mode, all other systems and devices are powered down safely.

The Hibernate mode can be entered in any of the following methods:

- Using the Hibernate Timeout
- Using the Schedule Power modes

Factory default Hibernate Timeout for this product in all countries or regions	3 days
--	--------

The amount of time the printer waits after a job is printed before it enters Hibernate mode can be modified between one hour and one month.

Off mode

If this product has an off mode which still consumes a small amount of power, then to completely stop product power consumption, disconnect the power supply cord from the electrical outlet.

Total energy usage

It is sometimes helpful to estimate the total product energy usage. Since power consumption claims are provided in power units of Watts, the power consumption should be multiplied by the time the product spends in each mode in order to calculate energy usage. The total product energy usage is the sum of each mode's energy usage.

Applicability of Regulation (EU) 2019/2015 and (EU) 2019/2020

Per Commission Regulation (EU) 2019/2015 and (EU) 2019/2020, the light source contained within this product or its component is intended to be used for Image Capture or Image Projection only, and is not intended for use in other applications.

Regulatory notices for wireless products

This section contains regulatory information that applies only to wireless models.

If in doubt as to whether your model is a wireless model, go to <http://support.lexmark.com>.

Modular component notice

Wireless models contain one of the following modular components:

Lexmark Regulatory Type/Model Number LEX-M07-001; FCC ID:IYLLEXM07001; Industry Canada IC:2376A-LEXM07001

Lexmark Regulatory Type/Model Number LEX-M08-001; FCC ID:IYLLEXM08001; IC:2376A-LEXM08001

To determine which modular components are installed in your particular product, refer to the labeling on your actual product.

Exposure to radio frequency radiation

The radiated output power of this device is far below the radio frequency exposure limits of the FCC and other regulatory agencies. A minimum separation of 20 cm (8 inches) must be maintained between the antenna and any persons for this device to satisfy the RF exposure requirements of the FCC and other regulatory agencies.

Industry Canada (Canada)

This device complies with Industry Canada license-exempt RSS standards. Operation is subject to the following two conditions: (1) this device may not cause interference, and (2) this device must accept any interference, including interference that may cause undesired operation of the device.

Industrie Canada (Canada)

Cet appareil est conforme aux normes RSS exemptes de licence d'Industrie Canada. Son fonctionnement est soumis aux deux conditions suivantes : (1) cet appareil ne doit pas causer d'interférences et (2) il doit accepter toutes les interférences, y compris les celles qui peuvent entraîner un fonctionnement indésirable.

Federal Communications Commission (FCC) compliance information statement

This product has been tested and found to comply with the limits for a Class B digital device, pursuant to Part 15 of the FCC Rules. Operation is subject to the following two conditions: (1) this device may not cause harmful interference, and (2) this device must accept any interference received, including interference that may cause undesired operation.

The FCC Class B limits are designed to provide reasonable protection against harmful interference when the equipment is operated in a residential installation. This equipment generates, uses, and can radiate radio frequency energy and, if not installed and used in accordance with the instructions, may cause harmful interference to radio communications. However, there is no guarantee that interference will not occur in a particular installation. If this equipment does cause harmful interference to radio or television reception, which can be determined by turning the equipment off and on, the user is encouraged to try to correct the interference by one or more of the following measures:

- Reorient or relocate the receiving antenna.
- Increase the separation between the equipment and receiver.
- Connect the equipment into an outlet on a circuit different from that to which the receiver is connected.
- Consult your point of purchase or service representative for additional suggestions.

The manufacturer is not responsible for radio or television interference caused by using other than recommended cables or by unauthorized changes or modifications to this equipment. Unauthorized changes or modifications could void the user's authority to operate this equipment.

Note: To assure compliance with FCC regulations on electromagnetic interference for a Class B computing device, use a properly shielded and grounded cable such as Lexmark part number 1021231 for parallel attach or 1021294 for USB attach. Use of a substitute cable not properly shielded and grounded may result in a violation of FCC regulations.

Any questions regarding this compliance information statement should be directed to:

Director of Lexmark Technology & Services
Lexmark International, Inc.
740 West New Circle Road
Lexington, KY 40550
Telephone: (859) 232-2000
E-mail: regulatory@lexmark.com

Industry Canada compliance statement

This Class B digital apparatus meets all requirements of the Canadian Interference-Causing Equipment Standard ICES-003.

Avis de conformité aux normes de l'industrie du Canada

Cet appareil numérique de classe B est conforme aux exigences de la norme canadienne relative aux équipements pouvant causer des interférences NMB-003.

日本の VCCI 規定

製品にこのマークが表示されている場合、次の要件を満たしています。



この装置は、クラス B 情報技術装置です。この装置は、家庭環境で使用することを目的としていますが、この装置がラジオやテレビジョン受信機に近接して使用されると、受信障害を引き起こすことがあります。

取扱説明書に従って正しい取り扱いをしてください。

VCCI-B

European Community (EC) directives conformity

This product is in conformity with the protection requirements of EC Council directives 2014/30/EU, 2014/35/EU, 2009/125/EC, and 2011/65/EU on the approximation and harmonization of the laws of the Member States relating to electromagnetic compatibility, safety of electrical equipment designed for use within certain voltage limits, the ecodesign of energy-related products, and on the restrictions of use of certain hazardous substances in electrical and electronic equipment.

The manufacturer of this product is: Lexmark International, Inc., 740 West New Circle Road, Lexington, KY, 40550 USA. The authorized representative is: Lexmark International Technology Hungária Kft., 8 Lechner Ödön fasor, Millennium Tower III, 1095 Budapest HUNGARY. A declaration of conformity to the requirements of the Directives is available upon request from the Authorized Representative or may be obtained at www.lexmark.com/en_us/about/regulatory-compliance/european-union-declaration-of-conformity.html.

This product satisfies the Class B limits of EN 55022 and EN55032 and safety requirements of EN 60950-1 or EN 62368-1.

European Community (EC) directives conformity

This product is in conformity with the protection requirements of EC Council directive 2014/53/EU on the approximation and harmonization of the laws of the Member States relating to radio equipment.

The manufacturer of this product is: Lexmark International, Inc., 740 West New Circle Road, Lexington, KY, 40550 USA. The authorized representative is: Lexmark International Technology Hungária Kft., 8 Lechner Ödön fasor, Millennium Tower III, 1095 Budapest HUNGARY. A declaration of conformity to the requirements of the

Directives is available upon request from the Authorized Representative or may be obtained at www.lexmark.com/en_us/about/regulatory-compliance/european-union-declaration-of-conformity.html.

Compliance is indicated by the CE marking:



EU and other countries statement of radio transmitter operational frequency bands and maximum RF power

This radio product transmits in the 2.4GHz (2.412–2.472GHz) band in the EU. The maximum transmitter EIRP power output, including antenna gain, is $\leq 20\text{dBm}$.

STATEMENT OF LIMITED WARRANTY FOR LEXMARK LASER PRINTERS, LEXMARK LED PRINTERS, AND LEXMARK MULTIFUNCTION LASER PRINTERS

Lexmark International, Inc., Lexington, KY

This limited warranty applies to the United States and Canada. For customers outside the U.S., refer to the country-specific warranty information that came with your product.

This limited warranty applies to this product only if it was originally purchased for your use, and not for resale, from Lexmark or a Lexmark Remarketer, referred to in this statement as “Remarketer.”

Limited warranty

Lexmark warrants that this product:

- Is manufactured from new parts, or new and serviceable used parts, which perform like new parts
- Is, during normal use, free from defects in material and workmanship

If this product does not function as warranted during the warranty period, contact a Remarketer or Lexmark for repair or replacement (at Lexmark's option).

If this product is a feature or option, this statement applies only when that feature or option is used with the product for which it was intended. To obtain warranty service, you may be required to present the feature or option with the product.

If you transfer this product to another user, warranty service under the terms of this statement is available to that user for the remainder of the warranty period. You should transfer proof of original purchase and this statement to that user.

Limited warranty service

The warranty period starts on the date of original purchase as shown on the purchase receipt and ends 12 months later provided that the warranty period for any supplies and for any maintenance items included with the printer shall end earlier if it, or its original contents, are substantially used up, depleted, or consumed. Fuser

Units, Transfer/Transport Units, Paper Feed items, if any, and any other items for which a Maintenance Kit is available are substantially consumed when the printer displays a “Life Warning” or “Scheduled Maintenance” message for such item.

To obtain warranty service you may be required to present proof of original purchase. You may be required to deliver your product to the Remarketer or Lexmark, or ship it prepaid and suitably packaged to a Lexmark designated location. You are responsible for loss of, or damage to, a product in transit to the Remarketer or the Lexmark designated location.

When warranty service involves the exchange of a product or part, the item replaced becomes the property of the Remarketer or Lexmark. The replacement may be a new or repaired item.

The replacement item assumes the remaining warranty period of the original product.

Replacement is not available to you if the product you present for exchange is defaced, altered, in need of a repair not included in warranty service, damaged beyond repair, or if the product is not free of all legal obligations, restrictions, liens, and encumbrances.

As part of your warranty service and/or replacement, Lexmark may update the firmware in your printer to the latest version. Firmware updates may modify printer settings and cause counterfeit and/or unauthorized products, supplies, parts, materials (such as toners and inks), software, or interfaces to stop working. Authorized use of genuine Lexmark products will not be impacted.

Before you present this product for warranty service, remove all print cartridges, programs, data, and removable storage media (unless directed otherwise by Lexmark).

For further explanation of your warranty alternatives and the nearest Lexmark authorized servicer in your area contact Lexmark on the World Wide Web.

Remote technical support is provided for this product throughout its warranty period. For products no longer covered by a Lexmark warranty, technical support may not be available or only be available for a fee.

Extent of limited warranty

Lexmark does not warrant uninterrupted or error-free operation of any product or the durability or longevity of prints produced by any product.

Warranty service does not include repair of failures caused by:

- Modification or unauthorized attachments
- Accidents, misuse, abuse or use inconsistent with Lexmark user’s guides, manuals, instructions or guidance
- Unsuitable physical or operating environment
- Maintenance by anyone other than Lexmark or a Lexmark authorized servicer
- Operation of a product beyond the limit of its duty cycle
- Use of printing media outside of Lexmark specifications
- Refurbishment, repair, refilling or remanufacture by a third party of products, supplies or parts
- Products, supplies, parts, materials (such as toners and inks), software, or interfaces not furnished by Lexmark

TO THE EXTENT PERMITTED BY APPLICABLE LAW, NEITHER LEXMARK NOR ITS THIRD PARTY SUPPLIERS OR REMARKETERS MAKE ANY OTHER WARRANTY OR CONDITION OF ANY KIND, WHETHER EXPRESS OR IMPLIED, WITH RESPECT TO THIS PRODUCT, AND SPECIFICALLY DISCLAIM THE IMPLIED WARRANTIES OR CONDITIONS OF MERCHANTABILITY, FITNESS FOR A PARTICULAR PURPOSE, AND SATISFACTORY QUALITY. ANY WARRANTIES THAT MAY NOT BE DISCLAIMED UNDER APPLICABLE LAW ARE LIMITED IN DURATION TO THE WARRANTY PERIOD. NO WARRANTIES, EXPRESS OR IMPLIED, WILL

APPLY AFTER THIS PERIOD. ALL INFORMATION, SPECIFICATIONS, PRICES, AND SERVICES ARE SUBJECT TO CHANGE AT ANY TIME WITHOUT NOTICE.

Limitation of liability

Your sole remedy under this limited warranty is set forth in this document. For any claim concerning performance or nonperformance of Lexmark or a Remarketer for this product under this limited warranty, you may recover actual damages up to the limit set forth in the following paragraph.

Lexmark's liability for actual damages from any cause whatsoever will be limited to the amount you paid for the product that caused the damages. This limitation of liability will not apply to claims by you for bodily injury or damage to real property or tangible personal property for which Lexmark is legally liable. **IN NO EVENT WILL LEXMARK BE LIABLE FOR ANY LOST PROFITS, LOST SAVINGS, INCIDENTAL DAMAGE, OR OTHER ECONOMIC OR CONSEQUENTIAL DAMAGES.** This is true even if you advise Lexmark or a Remarketer of the possibility of such damages. Lexmark is not liable for any claim by you based on a third party claim.

This limitation of remedies also applies to claims against any Suppliers and Remarketers of Lexmark. Lexmark's and its Suppliers' and Remarketers' limitations of remedies are not cumulative. Such Suppliers and Remarketers are intended beneficiaries of this limitation.

Additional rights

Some states do not allow limitations on how long an implied warranty lasts, or do not allow the exclusion or limitation of incidental or consequential damages, so the limitations or exclusions contained above may not apply to you.

This limited warranty gives you specific legal rights. You may also have other rights that vary from state to state.

Index

A

- accessing the controller board 119
- adding hardware options
 - print driver 125
- adding internal options
 - print driver 125
- adjusting brightness of printer display 72
- adjusting toner darkness 117
- AirPrint
 - using 22
- attaching cables 11
- avoiding paper jams 74

B

- blank pages 90
- brightness of printer display
 - adjusting 72

C

- cannot open Embedded Web Server 84
- card stock
 - size 14
- checking the printer connectivity 85
- checking the status
 - parts 57
 - supplies 57
- cleaning
 - exterior of the printer 57
 - interior of the printer 57
- cleaning the printer 57
- clearing jam
 - in door A 76
- configuring supply notifications 59
- configuring the SMTP server 84
- configuring Universal paper settings 14
- connecting the printer
 - to a wireless network 55
- connecting to a wireless network
 - using PIN method 55
 - using Push Button method 55
- conserving supplies 72

- contacting customer support 118
- control panel
 - buttons 12
 - indicator light 12
 - using 12
- controller board
 - accessing 119
- crooked print 103
- customer support
 - contacting 118

D

- deactivating the Wi-Fi network 56
- documents, printing
 - from a computer 21
 - from a mobile device 21
- dots on print 101

E

- Eco-Mode
 - setting 71
- emission notices 129, 133, 135
- envelopes
 - size 14
- environmental settings 71
- erasing printer memory 53, 54
- Ethernet menu 43
- Ethernet port 11
- exporting a configuration file
 - using the Embedded Web Server 125
- e-mail server
 - setting up 84

F

- FCC notices 133
- finding more information about the printer 8
- firmware, updating
 - using Embedded Web Server 127
 - using the control panel 126
- folder paper 94
- font sample list
 - printing 22

G

- Google Cloud Print
 - using 21

H

- hardware options
 - trays 123
- hardware options, adding
 - print driver 125
- Hibernate mode
 - setting 71

I

- identifying jam locations 75
- imaging unit
 - ordering 59
 - replacing 62
- importing a configuration file
 - using the Embedded Web Server 125
- indicator light
 - understanding the status 13
- installing a memory card 120
- installing an optional card 122
- installing the printer software 124
- internal options
 - font cards 119
 - installing 122
 - memory card 120
 - user flash 119
- internal options, adding
 - print driver 125

J

- jams
 - avoiding 74
- jams, clearing
 - in the duplex unit 81
 - in the multipurpose feeder 82
 - in the standard bin 80
 - trays 82

L

- labels
 - size 14
- Lexmark Mobile Print
 - using 21

- linking trays 17
- loading
 - multipurpose feeder 16
- loading envelopes
 - in the multipurpose feeder 16
- loading trays 14
- locating paper jams 75
- locating the security slot 53

M

- memory card
 - installing 120
- menu
 - 802.1x 48
 - About this Printer 30
 - Config Menu 28
 - Device 51
 - Ethernet 43
 - Google Cloud Print 50
 - HTML 36
 - HTTP/FTP Settings 49
 - Image 37
 - Information Sent to Lexmark 27
 - IPSec 47
 - Job Accounting 33
 - Layout 30
 - LPD Configuration 48
 - Media Types 39
 - Menu Settings Page 51
 - Network 52
 - Network Overview 40
 - Notifications 25
 - Out of Service Erase 30
 - PCL 35
 - PDF 34
 - PostScript 34
 - Power Management 26
 - Preferences 23
 - Print 52
 - Quality 32
 - Remote Operator Panel 24
 - Restore Factory Defaults 27
 - Setup 31
 - SNMP 46
 - TCP/IP 44
 - ThinPrint 50
 - Tray Configuration 38
 - Troubleshooting 52
 - Universal Setup 39
 - USB 49
 - Wi-Fi Direct 51
 - XPS 34

- menu map 23
- Menu Settings Page
 - printing 52
- menus
 - Wireless 40
- mobile device
 - printing from 21, 22
- Mopria Print Service
 - using 21
- mottled print 101
- moving the printer 9, 70
- multipurpose feeder
 - loading 16

N

- noise emission levels 129
- non-genuine toner 86
- Non-Lexmark supply 86
- non-volatile memory 54
 - erasing 53
- notices 129, 130, 131, 132, 133, 135

O

- optional card
 - installing 122
- ordering
 - imaging unit 59
 - toner cartridge 58

P

- paper jam in door A 76
- paper jam in the duplex unit 81
- paper jam in the multipurpose feeder 82
- paper jam in the rear door 79
- paper jam in trays 82
- paper jam, clearing
 - in the duplex unit 81
 - in the multipurpose feeder 82
 - in the rear door 79
 - trays 82
- paper jams
 - avoiding 74
- paper jams, clearing
 - in the standard bin 80
- personal identification number method 55
- pick roller assembly
 - replacing 66

- pick tires
 - replacing 64
- power button light
 - understanding the status 13
- power cord socket 11
- power saver modes
 - setting 71
- print driver
 - hardware options, adding 125
- print jobs not printed 115
- Print Quality Test Pages 52
- print quality troubleshooting
 - blank or white pages 90
 - crooked or skewed print 103
 - dark print 92
 - fine lines are not printed
 - correctly 93
 - folded or wrinkled paper 94
 - gray background on prints 95
 - horizontal light bands 97
 - light print 99
 - mottled print and dots 101
 - paper curl 102
 - repeating defects 104
 - solid black pages 105
 - text or images cut off 106
 - toner easily rubs off 108
 - vertical dark bands 109
 - vertical dark lines or streaks 110
 - vertical dark streaks with print
 - missing 111
 - vertical light bands 112
 - vertical white lines 113
- print troubleshooting
 - collated printing does not work 88
 - envelope seals when printing 87
 - incorrect margins 98
 - jammed pages are not reprinted 90
 - job prints from the wrong tray 117
 - job prints on the wrong paper 117
 - paper frequently jams 89
 - print jobs do not print 115
 - slow printing 114
 - tray linking does not work 89
- printer
 - minimum clearances 9
 - selecting a location 9

- shipping 71
- printer configurations 11
- printer display
 - adjusting the brightness 72
- printer hard disk memory 54
- printer information
 - finding 8
- printer is not responding 116
- printer menus 23
- printer messages
 - Non-Lexmark supply 86
 - refilled regular cartridge 86
 - Replace cartridge, printer region mismatch 86
- printer ports 11
- printer settings
 - restoring to factory defaults 54
- printer software, installing 124
- printer status 13
- printing
 - font sample list 22
 - from a computer 21
 - from a mobile device 21, 22
 - Menu Settings Page 52
 - printing a font sample list 22
 - printing a network setup page 85
 - printing from a computer 21
 - Push Button method 55

R

- recycling
 - Lexmark packaging 72
 - Lexmark products 72
- removing paper jam
 - in door A 76
- Replace cartridge, printer region mismatch 86
- replacing supplies
 - imaging unit 62
 - toner cartridge 60
- replacing the pick roller assembly 66
- replacing the pick tires 64
- resetting
 - supply usage counters 86
 - resetting the supply usage counters 86
- Restore Factory Defaults menu 27
- restoring factory default settings 54

S

- safety information 6, 7
- securing printer memory 54
- security slot
 - locating 53
- selecting a location for the printer 9
- shipping the printer 71
- skewed print 103
- Sleep mode
 - setting 71
- SMTP server
 - configuring 84
- specialty media
 - setting the paper size 14
 - setting the paper type 14
- statement of volatility 54
- status of parts and supplies 57
- supplies
 - conserving 72
 - supplies, ordering
 - toner cartridge 58
 - supply notifications
 - configuring 59
 - supply usage counters
 - resetting 86
 - supported paper sizes 18
 - supported paper types 19
 - supported paper weights 20

T

- third-party supplies 86
- toner cartridge
 - ordering 58
 - replacing 60
- toner darkness
 - adjusting 117
- trays
 - installing 123
 - loading 14
- troubleshooting
 - cannot open Embedded Web Server 84
 - printer is not responding 116
- troubleshooting, print
 - collated printing does not work 88
 - envelope seals when printing 87
 - incorrect margins 98

- troubleshooting, print quality
 - blank or white pages 90
 - crooked or skewed print 103
 - dark print 92
 - fine lines are not printed correctly 93
 - folded or wrinkled paper 94
 - gray background on prints 95
 - horizontal light bands 97
 - light print 99
 - mottled print and dots 101
 - paper curl 102
 - repeating defects 104
 - solid black pages 105
 - text or images cut off 106
 - toner easily rubs off 108
 - vertical dark bands 109
 - vertical dark lines or streaks 110
 - vertical dark streaks with print missing 111
 - vertical light bands 112
 - vertical white lines 113

U

- Universal paper settings
 - configuring 14
- unlinking trays 17
- updating firmware
 - using Embedded Web Server 127
 - using the control panel 126
- USB printer port 11
- using
 - genuine Lexmark parts 57
 - genuine Lexmark supplies 57

V

- vertical dark lines on prints 110
- vertical streaks on prints 110
- volatile memory 54
 - erasing 53

W

white lines 113

white pages 90

Wireless menu 40

wireless network

connecting the printer to 55

Wi-Fi Protected Setup 55

wireless networking 55

Wi-Fi network

deactivating 56

Wi-Fi Protected Setup

wireless network 55

wrinkled paper 94